



P/N 126807-01 REV. E 01/2019



## Installation and Operation Instructions

### Unvented (Vent-Free) Gas Log Heater

#### Models

MAGNIFLAME24MN	MAGNIFLAME30MN
MAGNIFLAME24VN	MAGNIFLAME30VN
MAGNIFLAME24MP	MAGNIFLAME30MP
MAGNIFLAME24VP	MAGNIFLAME30VP

#### For use with log sets

SOUTHERNCOMFORT24A/B	SHADYHOLLOW24A/B
SOUTHERNCOMFORT30A/B	SHADYHOLLOW30A/B
SOUTHERNCOMFORT36A/B	SHADYHOLLOW36A/B

**INSTALLER:** Leave this manual with the appliance.

**CONSUMER:** Retain this manual for future reference.

This appliance may be installed in an aftermarket permanently located, manufactured (mobile) home, where not prohibited by local codes. This appliance is only for use with the type of gas indicated on the rating plate. This appliance is not convertible for use with other gases.

**WARNING:** This appliance is for installation only in a solid-fuel burning masonry or UL127 factory-built fireplace or in a listed ventless firebox enclosure. It is design-certified for these installations in accordance with ANSI Z21.11.2. Exception: DO NOT install this appliance in a factory-built fireplace that includes instructions stating it has not been tested or should not be used with unvented gas logs.

This is an unvented gas-fired heater. It uses air (oxygen) from the room in which it is installed. Provisions for adequate combustion and ventilation air must be provided. Refer to Air for Combustion and Ventilation section on *Page 6* of this manual.

**⚠ WARNING:** If the information in this manual is not followed exactly, a fire or explosion may result causing property damage, personal injury or loss of life.

- Do not store or use gasoline or other flammable vapors and liquids in the vicinity of this or any other appliance.
- **WHAT TO DO IF YOU SMELL GAS**
  - Do not try to light any appliance.
  - Do not touch any electrical switch; do not use any phone in your building.
  - Immediately call your gas supplier from a neighbor's phone. Follow the gas supplier's instructions.
  - If you cannot reach your gas supplier, call the fire department.
- Installation and service must be performed by a qualified installer, service agency or the gas supplier.

**Thank you for your purchase. We appreciate your business!**

Please carefully read and follow all instructions in this manual. **Pay special attention to all warnings and safety information.**

Following these safety, care, and operation instructions will help ensure many years of dependable and enjoyable service from your fireplace.

**Please read and understand these instructions before installing or operating.**



## TABLE OF CONTENTS

Safety.....	2
Product Identification.....	5
Local Codes .....	5
Optional Remote Control Accessories.....	5
Unpacking.....	5
Product Features.....	6
Air For Combustion and Ventilation.....	6
Installation .....	8
Operation .....	23
Inspecting Burners.....	29
Cleaning and Maintenance .....	30
Specifications.....	31
Wiring Diagram.....	31
Troubleshooting .....	32
Parts .....	36
Replacement Parts.....	40
Service Hints.....	40
Technical Service .....	40
Accessories.....	40
Warranty .....	43

## SAFETY

**⚠ WARNING: FIRE, EXPLOSION, AND ASPHYXIATION HAZARD**

Improper adjustment, alteration, service, maintenance, or installation of this heater or its controls can cause death or serious injury.

Read and follow instructions and precautions in User's Information Manual provided with this heater.

**⚠ WARNING:** This appliance is for installation only in a solid-fuel burning masonry or UL127 factory-built fireplace or in a listed ventless firebox enclosure. It is design-certified for these installations in accordance with ANSI Z21.11.2. Exception: **DO NOT** install this appliance in a factory-built fireplace that includes instructions stating it has not been tested or should not be used with unvented gas logs.

**⚠ WARNING:** Vent-free products are prohibited for bedroom and bathroom installation in the Commonwealth of Massachusetts.

**⚠ WARNING:** This product can expose you to chemicals including Carbon Black, which is known to the State of California to cause cancer, and Carbon Monoxide, which is known to the State of California to cause birth defects or other reproductive harm. For more information go to [www.P65Warnings.ca.gov](http://www.P65Warnings.ca.gov)

**⚠ WARNING:** This is an unvented gas-fired heater. It uses air (oxygen) from the room in which it is installed. Provisions for adequate combustion and ventilation air must be provided. Refer to **Air for Combustion and Ventilation** section on *Page 6* of this manual.

This appliance may be installed in an aftermarket,\* permanently located, manufactured (mobile) home, where not prohibited by local codes. This appliance is only for use with the type of gas indicated on the rating plate. This appliance is not convertible for use with other gases.

\* Aftermarket: Completion of sale, not for purpose of resale, from the manufacturer

**IMPORTANT:** Read this owner's manual carefully and completely before trying to assemble, operate or service this appliance. Improper use of this fireplace can cause serious injury or death from burns, fire, explosion, electrical shock and carbon monoxide poisoning.

Any safety screen, guard, or barrier removed for servicing an appliance must be replaced prior to operating the heater. The firescreen or guard designed for this unvented appliance must be installed prior to operation.

## SAFETY *Continued*

**⚠ DANGER: Carbon monoxide poisoning may lead to death!**

**Carbon Monoxide Poisoning:** Early signs of carbon monoxide poisoning resemble the flu, with headaches, dizziness, or nausea. If you have these signs, the heater may not be working properly. **Get fresh air at once!** Have heater serviced. Some people are more affected by carbon monoxide than others. These include pregnant women, people with heart or lung disease or anemia, those under the influence of alcohol, and those at high altitudes.

**Natural and Propane/LP Gas:** Natural and propane/LP gases are fuel gases. Fuel gases are odorless. An odor-making agent is added to fuel gases. The odor helps you detect a fuel gas leak. However, the odor added to fuel gas can fade. Fuel gas may be present even though no odor exists.

Make certain you read and understand all warnings. Keep this manual for reference. It is your guide to safe and proper operation of this heater.

**⚠ WARNING: Any change to this heater or its controls can be dangerous.**

**⚠ WARNING: Do not use a blower insert, heat exchanger insert or other accessory not approved for use with this heater.**

**⚠ WARNING: Do not allow fans to blow directly into the fireplace. Avoid any drafts that alter burner flame patterns. Ceiling fans can create drafts that alter burner flame patterns. Altered burner patterns can cause sooting.**

**⚠ WARNING: Do not place log scraps or volcanic stone on burner.**

**Due to high temperatures, the appliance should be located out of traffic and away from furniture and draperies.**

**Do not place clothing or other flammable material on or near the appliance. Never place any objects on the heater.**

**Appliance base assembly becomes very hot when running appliance.**

**Children and adults should be alerted to the hazard of high surface temperature and should stay away to avoid burns or clothing ignition. Heater will remain hot for a time after shutdown. Allow surface to cool before touching.**

**⚠ WARNING: Young children should be carefully supervised when they are in the same room with the appliance. When using the hand-held remote accessory, keep selector switch in the OFF position to prevent children from turning on burners with remote.**

**You must operate this heater with the fireplace screen and hood in place. Make sure fireplace screen and hood are in place before running appliance. The fireplace screen shall have openings for introduction of combustion air.**

**Keep the appliance area clear and free from combustible materials, gasoline and other flammable vapors and liquids.**

**Solid-fuels shall not be burned in a fireplace in which an unvented room heater is installed.**

**Installation and repair should be done by a qualified service person. The appliance should be inspected before use and at least annually by a professional service person. More frequent cleaning may be required due to excessive lint from carpeting, bedding material, etc. It is imperative that control compartments, burners, and circulating air passageways of the appliance be kept clean.**

**1. WARNING: This appliance is only for use with the type of gas indicated on the rating plate. This appliance is not convertible for use with other gases.**

2. Do not place propane/LP supply tank(s) inside any structure. Locate propane/LP supply tank(s) outdoors (propane/LP units only).
3. To prevent performance problems, the use of a propane/LP tank of less than 100 lbs. capacity is not recommended (propane/LP units only).
4. If you smell gas
  - shut off gas supply
  - do not try to light any appliance
  - do not touch any electrical switch; do not use any phone in your building
  - immediately call your gas supplier from a neighbor's phone. Follow the gas supplier's instructions
  - if you cannot reach your gas supplier, call the fire department
5. This heater shall not be installed in a bedroom or bathroom unless installed as a vented appliance (see [Installing Damper Clamp Accessory for Vented Operation](#), **Page 11**).

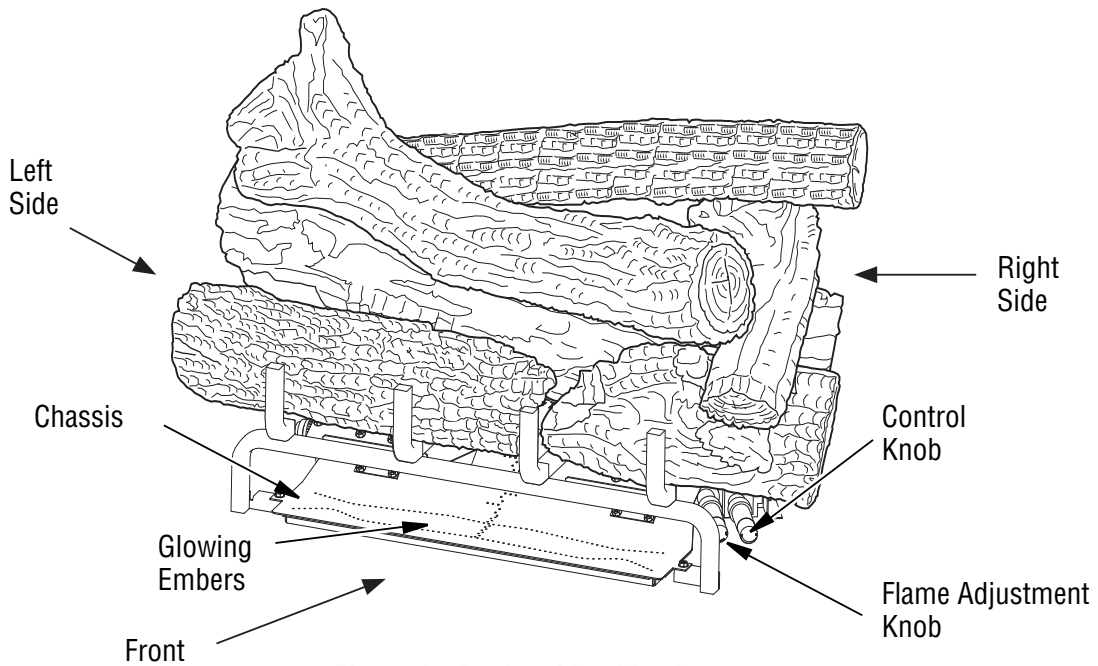
## SAFETY

### Continued

**1. WARNING: This appliance is only for use with the type of gas indicated on the rating plate. This appliance is not convertible for use with other gases.**

2. Do not place propane/LP supply tank(s) inside any structure. Locate propane/LP supply tank(s) outdoors (propane/LP units only).
3. If you smell gas
  - shut off gas supply
  - do not try to light any appliance
  - do not touch any electrical switch; do not use any phone in your building
  - immediately call your gas supplier from a neighbor's phone. Follow the gas supplier's instructions
  - if you cannot reach your gas supplier, call the fire department
4. This appliance shall not be installed in a bedroom or bathroom, unless installed as a vented appliance. See *Installing Damper Clamp Accessory for Vented Operation, Page 12*. This gas log set may not be installed as a vented appliance in a bedroom or bathroom in the Commonwealth of Massachusetts.
5. **WARNING: Before installing in a solid fuel-burning fireplace, the chimney flue and firebox must be cleaned of soot, creosote, ashes and loose paint by a qualified chimney cleaner.** Creosote will ignite if highly heated. A dirty chimney flue may create and distribute soot within the house. Inspect chimney flue for damage. If damaged, repair flue and firebox before operating appliance.
6. Do not burn solid-fuel in a fireplace in which an unvented appliance is installed.
7. If fireplace has glass doors, never operate this appliance with glass doors closed. Any glass doors shall be fully opened when the appliance is in operation. If you operate appliance with doors closed, heat buildup inside fireplace will cause glass to burst. Make sure there are no obstructions across openings of fireplace.
8. To prevent the creation of soot, follow the instructions in *Cleaning and Maintenance, Page 30*.
9. Before using furniture polish, wax, carpet cleaner or similar products, turn appliance off. If heated, the vapors from these products may create a white powder residue within burner box or on adjacent walls and furniture.
10. This appliance needs fresh, outside air ventilation to run properly. This appliance has an Oxygen Depletion Sensing (ODS) safety shutoff system. The ODS shuts down the appliance if enough fresh air is not available. See *Air for Combustion and Ventilation, Page 6*. If appliance keeps shutting off, see *Troubleshooting, Page 32*.
11. Do not run appliance
  - where flammable liquids or vapors are used or stored
  - under dusty conditions
12. Do not use this appliance to cook food or burn paper or other objects.
13. Do not use this room heater if any part has been under water. Immediately call a qualified service technician to inspect the room heater and to replace any part of the control system and any gas control which has been under water.
14. Do not operate appliance if any log is broken. Do not operate appliance if a log is chipped (dime-sized or larger).
15. Turn appliance off and let cool before servicing, installing or repairing. Make sure the selector switch is in the OFF position. Only a qualified service person should install, service or repair appliance.
16. Make sure the remote is set to the OFF position when you are away from home for long periods of time.
17. Remote-ready appliances must not be connected to any external electrical source.
18. Operating appliance above elevations of 4,500 feet may cause pilot outage.
19. To prevent performance problems, do not use propane/LP fuel tank of less than 100 lb. capacity (propane/LP units only).
20. Provide adequate clearances around air openings.
21. When installing as a vented appliance in a manufactured home or mobile home, the installation must conform with the Manufactured Home Construction and Safety Standard, Title 24 CFR, Part 3280, or when applicable, with Manufacture Home Installations Standard, ANSI/NCBCS A225.1/NFPZ 501A.
22. This log heater is designed to be smokeless. If logs ever appear to smoke, turn off heater and call a qualified service person.  
**NOTE:** *During initial operation, slight smoking could occur due to log curing and heater burning manufacturing residues.*

## PRODUCT IDENTIFICATION



**Figure 1 - Product Identification**

### LOCAL CODES

Install and use appliance with care. The installation must conform with local codes or in the absence of local codes, to the latest edition of *The National Fuel Gas Code, ANSI Z223.1/NFPA 54\**.

\*Available from:

American National Standards Institute, Inc.  
25 West 43rd Street, 4th floor  
New York, NY 10036  
National Fire Protection Association, Inc.  
1 Batterymarch Park  
Quincy, MA 02169-7471

### UNPACKING

1. Remove log set assembly from carton.  
**NOTE:** Do not pick up appliance base assembly by burners. This could damage appliance. Always handle base assembly by grate.
2. Remove all protective packaging applied to logs and appliance for shipment.
3. Check appliance for any shipping damage. If appliance is damaged, promptly inform dealer where you purchased the appliance.

**CAUTION:** Do not remove the data plates from the grate assembly. The data plates contain important warranty and safety information.

### COMMONWEALTH OF MASSACHUSETTS REQUIREMENTS

These appliances are approved for installation in the US state of Massachusetts if the following additional requirements are met:

- Un-vented Room Heaters shall be installed in accordance with 527 CMR 30.
- Installation and repair must be done by a plumber or gas fitter licensed in the Commonwealth of Massachusetts.
- The flexible gas line connector used shall not exceed 36 inches (92 centimeters) in length.
- The individual manual shut-off must be a T-handle type valve.
- Unvented appliances may NOT be installed in bedrooms or bathrooms.
- A working smoke detector must be installed in the area where vent-free appliances are installed.

Seller of unvented propane or natural gas-fired supplemental room heaters shall provide to each purchaser a copy of 527 CMR 30 upon sale of the unit.

## PRODUCT FEATURES

### OPERATION

This appliance is clean burning. It requires no outside venting. There is no heat loss out a vent or up a chimney. Heat is generated by both realistic flames and glowing coals. This appliance is designed for vent-free operation with flue damper closed. It has been tested and approved to the ANSI Z21.11.2 standard for unvented room heaters. State and local codes in some areas prohibit the use of unvented appliances. This appliance may also be operated as a vented decorative (ANSI Z21.60) product by opening the flue damper.

### SAFETY DEVICE

This appliance has a pilot with an Oxygen Depletion Sensing (ODS) safety shutoff system. The ODS/pilot is a required feature for unvented appliances. The ODS/pilot shuts off the appliance if there is not enough fresh air.

### ELECTRONIC IGNITION SYSTEM

This appliance has an electronic igniter to light appliance fuel supply.

## AIR FOR COMBUSTION AND VENTILATION

**⚠ WARNING: This heater shall not be installed in a room or space unless the required volume of indoor combustion air is provided by the method described in the National Fuel Gas Code, ANSI Z223.1/NFPA 54, the International Fuel Gas Code, or applicable local codes. Read the following instructions to ensure proper fresh air for this and other fuel-burning appliances in your home.**

Today's homes are built more energy efficient than ever. New materials, increased insulation and new construction methods help reduce heat loss in homes. Homeowners apply weather strip and caulk around windows and doors to keep the cold air out and the warm air in. During heating months, homeowners want their homes as airtight as possible.

While it is good to make your home energy efficient, your home needs to breathe. Fresh air must enter your home. All fuel-burning appliances need fresh air for proper combustion and ventilation.

Exhaust fans, some fireplaces, clothes dryers and some fuel-burning appliances draw air from the house to operate. You must provide adequate fresh air for these appliances. That will ensure proper venting of vented fuel-burning appliances.

### PROVIDING ADEQUATE VENTILATION

The following are excerpts from *National Fuel Gas Code, ANSI Z223.1/NFPA 54, Air for Combustion and Ventilation*.

All spaces in homes fall into one of the three

following ventilation classifications:

1. Unusually Tight Construction
2. Unconfined Space
3. Confined Space

The information on **Pages 6 through 8** will help you classify your space and provide adequate ventilation.

#### Unusually Tight Construction

The air that leaks around doors and windows may provide enough fresh air for combustion and ventilation. However, in buildings of unusually tight construction, you must provide additional fresh air.

**Unusually tight construction is defined as construction where:**

- a. **walls and ceilings exposed to the outside atmosphere have a continuous water vapor retarder with a rating of one perm ( $6 \times 10^{-11}$  kg per pa-sec- $m^2$ ) or less with openings gasketed or sealed and**
- b. **weather stripping has been added on openable windows and doors and**
- c. **caulking or sealants are applied to areas such as joints around window and door frames, between sole plates and floors, between wall-ceiling joints, between wall panels, at penetrations for plumbing, electrical and gas lines and at other openings.**

If your home meets all three criteria above, you must provide additional fresh air. See *Ventilation Air From Outdoors, Page 8*.

If your home does not meet all three criteria above, proceed to *Determining Fresh-Air Flow For Heater Location, Page 7*.

#### Confined and Unconfined Space

The National Fuel Gas Code, ANSI Z223.1/NFPA54 allows two methods for determining whether the space in which the heater is being installed is confined or unconfined space. The standard method defines a confined space as a space whose volume

# AIR FOR COMBUSTION AND VENTILATION

## Continued

is less than 50 cubic feet per 1,000 Btu/hr (4.8 m<sup>3</sup> per kw) of the aggregate input rating of all appliances installed in that space and an unconfined space as a space whose volume is not less than 50 cubic feet per 1,000 Btu/hr (4.8 m<sup>3</sup> per kw) of the aggregate input rating of all appliances installed in that space. Rooms communicating directly with the space in which the appliances are installed\*, through openings not furnished with doors, are considered a part of the unconfined space.

Where the air infiltration rate of a structure is known, the Known Air Infiltration Rate Method may be used. Follow The National Fuel Gas Code, ANSI Z223.1/NFPA 54 to use this method to determine if the space is confined or unconfined.

\* Adjoining rooms are communicating only if there are doorless passageways or ventilation grills between them.

### DETERMINING FRESH-AIR FLOW FOR HEATER LOCATION

#### Determining if You Have a Confined or Unconfined Space Using the Standard Method

Use this work sheet to determine if you have a confined or unconfined space.

**Space:** Includes the room in which you will install fireplace plus any adjoining rooms with doorless passageways or ventilation grills between the rooms.

1. Determine the volume of the space (length x width x height).

Length x Width x Height = \_\_\_\_\_ cu. ft.  
(volume of space)

*Example:* Space size 20 ft. (length) x 16 ft. (width) x 8 ft. (ceiling height) = 2560 cu. ft. (volume of space)

If additional ventilation to adjoining room is supplied with grills or openings, add the volume of these rooms to the total volume of the space.

2. Multiply the space volume by 20 to determine the maximum Btu/Hr the space can support.

\_\_\_\_\_ (volume of space) x 20 = (Maximum Btu/Hr the space can support)

*Example:* 2560 cu. ft. (volume of space) x 20 = 51,200 (maximum Btu/Hr the space can support)

3. Add the Btu/Hr of all fuel-burning appliances in the space.

Vent-free fireplace	_____	Btu/Hr
Gas water heater*	_____	Btu/Hr
Gas furnace	_____	Btu/Hr
Vented gas heater	_____	Btu/Hr
Gas fireplace logs	_____	Btu/Hr
Other gas appliances*	+ _____	Btu/Hr
Total	= _____	Btu/Hr

\* Do not include direct-vent gas appliances. Direct-vent draws combustion air from the outdoors and vents to the outdoors.

*Example:*

Gas water heater	_____	40,000	Btu/Hr
Vent-free fireplace	+ _____	33,000	Btu/Hr
Total	= _____	73,000	Btu/Hr

4. Compare the maximum Btu/Hr the space can support with the actual amount of Btu/Hr used.

\_\_\_\_\_ Btu/Hr (maximum the space can support)

\_\_\_\_\_ Btu/Hr (actual amount used)

*Example:* 51,200 Btu/Hr (maximum the space can support)

73,000 Btu/Hr (actual amount of Btu/Hr used)

The space in the above example is a confined space because the actual Btu/Hr used is more than the maximum Btu/Hr the space can support. You must provide additional fresh air. Your options are as follows:

- A. Rework worksheet, adding the space of an adjoining room. If the extra space provides an unconfined space, remove door to adjoining room or add ventilation grills between rooms. See *Ventilation Air From Inside Building, Page 8*.
- B. Vent room directly to the outdoors. See *Ventilation Air From Outdoors, Page 8*.
- C. Install a lower Btu/Hr appliance, if lower Btu/Hr size makes room unconfined.

If the actual Btu/Hr used is less than the maximum Btu/Hr the space can support, the space is an unconfined space. You will need no additional fresh air ventilation.

**⚠ WARNING: If the area in which the appliance may be operated does not meet the required volume for indoor combustion air, combustion and ventilation air shall be provided by one of the methods described in the National Fuel Gas Code, ANSI Z223.1/NFPA 54, the International Fuel Gas Code, or applicable local codes.**

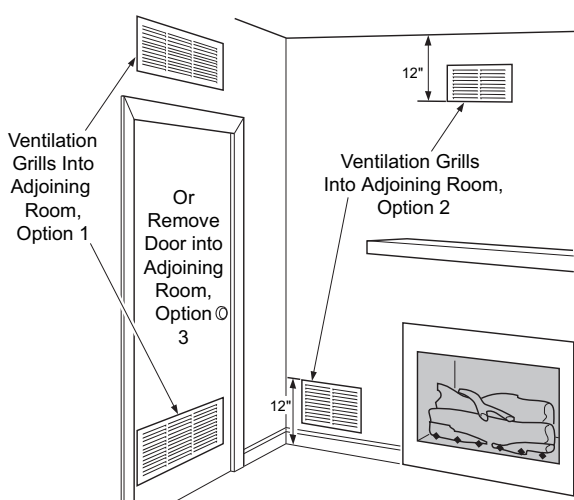
# AIR FOR COMBUSTION AND VENTILATION

*Continued*

## VENTILATION AIR

### Ventilation Air From Inside Building

This fresh air would come from an adjoining unconfined space. When ventilating to an adjoining unconfined space, you must provide two permanent openings: one within 12" of the ceiling and one within 12" of the floor on the wall connecting the two spaces (see options 1 and 2, **Figure 2**). You can also remove door into adjoining room (see option 3, **Figure 2**). Follow the *National Fuel Gas Code, ANSI Z223.1/NFPA 54, Air for Combustion and Ventilation* for required size of ventilation grills or ducts.

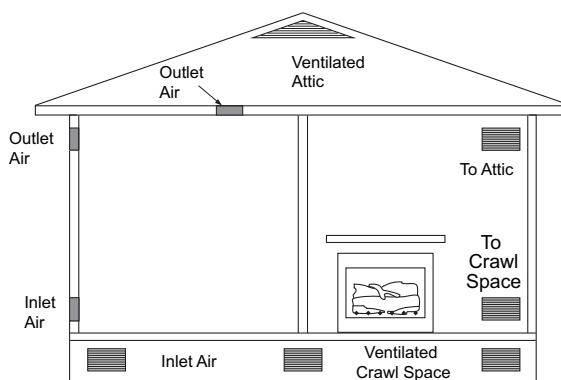


**Figure 2 - Ventilation Air from Inside Building**

### Ventilation Air From Outdoors

Provide extra fresh air by using ventilation grills or ducts. You must provide two permanent openings: one within 12" of the ceiling and one within 12" of the floor. Connect these items directly to the outdoors or spaces open to the outdoors. These spaces include attics and crawl spaces. Follow the *National Fuel Gas Code, ANSI Z223.1/NFPA 54, Air for Combustion and Ventilation* for required size of ventilation grills or ducts.

**IMPORTANT:** Do not provide openings for inlet or outlet air into attic if attic has a thermostat-controlled power vent. Heated air entering the attic will activate the power vent.



**Figure 3 - Ventilation Air from Outdoors**

## INSTALLATION

**NOTICE:** This appliance is intended for supplemental heating. Use this heater along with your primary heating system. Do not install this heater as your primary heat source. If you have a central heating system, you may run system's circulating blower while using heater. This will help circulate the heat throughout the house. In the event of a power outage, you can use this heater as your primary heat source.

**WARNING:** A qualified service person must install heater. Follow all local codes.

**NOTICE:** State or local codes may only allow operation of this appliance in a vented configuration. Check your state or local codes.

**WARNING:** Make sure the selector switch is in the OFF position before installing heater.

**WARNING:** Any outside air ducts and/or ash dumps in the fireplace shall be permanently closed at time of appliance installation.

**WARNING:** Seal any fresh air vents or ash clean-out doors located on floor or wall of fireplace. If not, drafting may cause pilot outage or sooting. Use a heat-resistant sealant. Do not seal chimney flue damper.



## INSTALLATION

*Continued*

**⚠ WARNING:** Before installing in a solid fuel-burning fireplace, the chimney flue and firebox must be cleaned of soot, creosote, ashes and loose paint by a qualified chimney cleaner. Creosote will ignite if highly heated. A dirty chimney flue may create and distribute soot within the house. Inspect chimney and firebox flue for damage. If damaged, repair flue and firebox before operating appliance.

**⚠ WARNING:** Never install the appliance

- in a bedroom or bathroom unless installed as a vented appliance, see *Page 12*
- in a recreational vehicle
- where curtains, furniture, clothing or other flammable objects are less than 36" from front, 42" from top of appliance; for side clearances see *Figure 4, Page 10*
- in high traffic areas
- in windy or drafty areas

**⚠ CAUTION:** This appliance creates warm air currents. These currents move heat to wall surfaces next to heater. Installing heater next to vinyl or cloth wall coverings or operating heater where impurities (such as, but not limited to, tobacco smoke, aromatic candles, cleaning fluids, oil or kerosene lamps, etc.) in the air exist, may discolor walls or cause odors.

**IMPORTANT:** Vent-free appliances add moisture to the air. Although this is beneficial, installing appliance in rooms without enough ventilation air may cause mildew to form from too much moisture. See *Air for Combustion and Ventilation, Page 6*.

## CHECK GAS TYPE

Use the correct type of gas (natural or propane/LP). If your gas supply is not the correct gas type, do not install appliance. Call the dealer where you purchased the appliance for proper type appliance.

**⚠ WARNING:** This appliance is equipped for either natural gas or propane/LP gas but not both. Gas type is indicated on the rating plate. Field conversion is not permitted.

## INSTALLATION AND CLEARANCES FOR VENT-FREE OPERATION

**⚠ WARNING:** Maintain the minimum clearances. If you can, provide greater clearances from floor, ceiling and adjoining wall.

### MINIMUM FIREPLACE CLEARANCE TO COMBUSTIBLE MATERIALS

Side Wall 16", Ceiling 42"  
Floor 5", Front: 36"

### LOG SIZING REQUIREMENTS

Log Size	Minimum Firebox Size			
	Height	Depth	Front Width	Rear* Width
SOUTHERNCOMFORT24A/B SHADYHOLLOW24A/B	29"	15.5"	32.5"	22.75"
SOUTHERNCOMFORT30A/B SHADYHOLLOW30A/B	29"	15.5"	39"	26.75"
SOUTHERNCOMFORT36A/B SHADYHOLLOW36A/B	29"	20"	47"	33"

\* Also approved for use in VEGA42 and VALIANT42 Series fireplaces.

Carefully follow the instructions below. This will ensure safe installation into a masonry, UL127-listed manufactured fireplace or listed vent-free firebox.

### Minimum Clearances For Side Combustible Material, Side Wall and Ceiling

A. Clearances from the side of the fireplace cabinet to any combustible material and wall should follow diagram in *Figure 4, Page 10*.

**Example:** The face of a mantel, bookshelf, etc. is made of combustible material and protrudes 3-1/2" from the wall. This combustible material must be 4" from the side of the fireplace cabinet (see *Figure 4, Page 10*).

# INSTALLATION

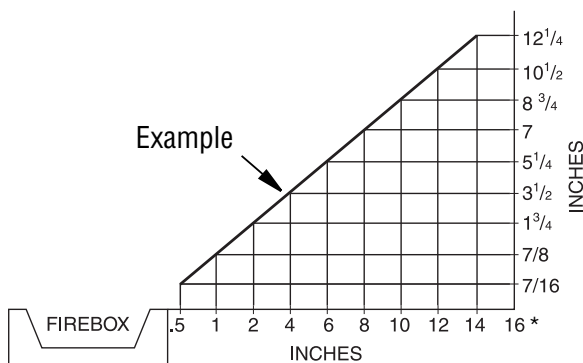
## Continued

**NOTE:** When installing your gas logs into a manufactured firebox, follow firebox manufacturer's instructions for minimum clearances to combustible materials.

- B. Clearances from the top of the fireplace opening to the ceiling should not be less than 42".

**NOTICE:** Manual control appliances may be used as a vented product. If so, you must always run appliance with chimney flue damper open. If running appliance with damper open, noncombustible material above fireplace opening is not needed. Go to Installing Damper Clamp Accessory for Vented Operation, Page 12.

Maintain adequate clearances for accessibility for purposes of servicing and proper operation.



\*Minimum 16" from Side Wall

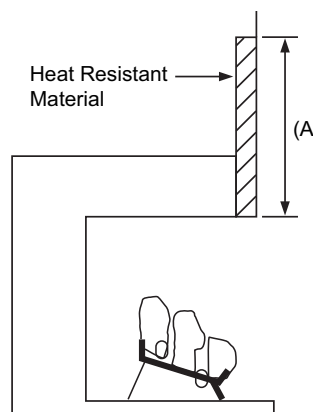
**Figure 4 - Minimum Clearance for Combustible to Wall**

### Minimum Noncombustible Material Clearances If Not Using Mantel

**NOTE:** If using a mantel proceed to If Using Mantel. If not using a mantel, follow these instructions.

You must have noncombustible material(s) above the fireplace opening. Noncombustible materials (such as slate, marble, tile, etc.) must be at least 1/2" thick. With sheet metal, you must have noncombustible material behind it. Noncombustible material must extend at least 8" up (for all models). If noncombustible material is less than 12", you must install the fireplace hood accessory (24" and 30" Models Only). See **Figure 5** for minimum clearances.

Noncombustible Material Distance (A)	Requirements for Safe Installation
12" or more	Noncombustible material OK.
Between 8" and 12"	Install fireplace hood accessory (GA6050 - see <u>Accessories, Page 40</u> ).
Less than 8"	Noncombustible material must be extended to at least 8". See <u>Between 8" and 12"</u> , above. If you cannot extend material, you must operate appliance with flue damper open.



**Figure 5 - Heat Resistant Material (Slate, Marble, Tile, etc.) Above Fireplace**

### If Using Mantel

You must have noncombustible material(s) above the fireplace opening. Noncombustible materials (such as slate, marble, tile, etc.) must be at least 1/2" thick. With sheet metal, you must have noncombustible material behind it. Noncombustible material must extend at least 8" up (for all models). If noncombustible material is less than 12", you must install the fireplace hood accessory (24" and 30" Models Only). Even if noncombustible material is more than 12", you may need the hood accessory to deflect heat away from your mantel shelf. See **Figure 5** and **Figures 6 and 7, Page 11**, for minimum clearances.

**IMPORTANT:** If you cannot meet these minimum clearances, you must operate appliance with chimney flue damper open. Go to Installing Damper Clamp Accessory for Vented Operation, Page 12.

# INSTALLATION

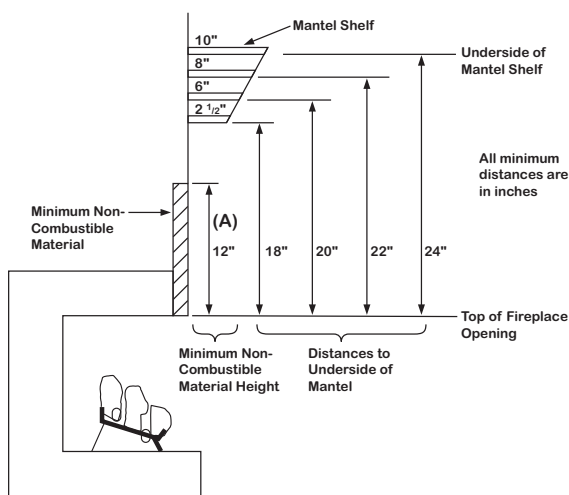
## Continued

### MANTEL CLEARANCES

In addition to meeting noncombustible material clearances, you must also meet required clearances between fireplace opening and mantel shelf. If you do not meet the clearances listed below, you will need a hood.

#### Determining Minimum Mantel Clearance

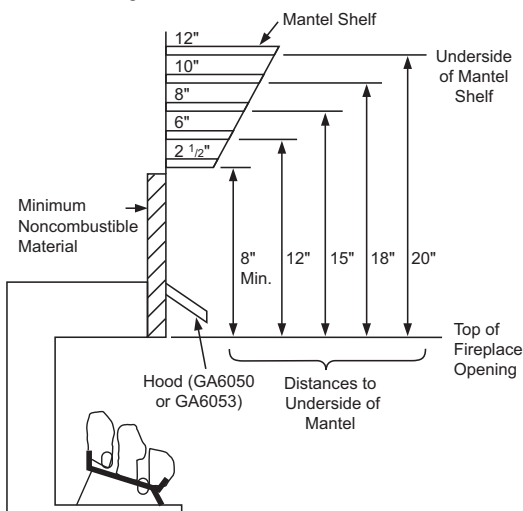
If you meet minimum clearance between mantel shelf and top of fireplace opening, a hood is not required (see **Figure 6**).



**Figure 6 - Minimum Mantel Clearances Without Using Hood**

#### Determining Minimum Mantel Clearance When Using a Hood

If minimum clearances in **Figure 6**, are not met, you must have a hood. When using a hood there are still certain minimum mantel clearances required. Follow minimum clearances shown in **Figure 7**, when using hood.



**Figure 7 - Minimum Mantel Clearances When Using Hood**

Minimum clearance requirements include any projections such as shelves, window sills, mantels, etc. above the appliance.

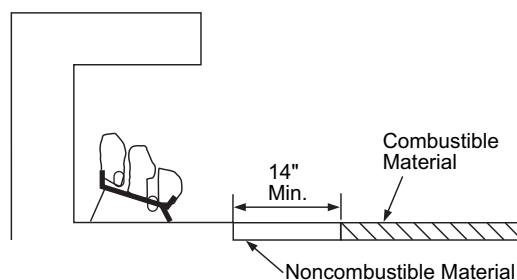
**NOTICE: Surface temperatures of adjacent walls and mantels become hot during operation. Walls and mantels above the firebox may become hot to the touch. If installed properly, these temperatures meet the requirement of the national product standard. Follow all minimum clearances shown in this manual.**

**NOTICE: If your installation does not meet the minimum clearances shown, you must do one of the following:**

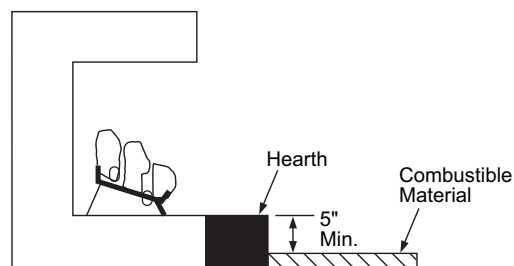
- operate the logs only with the flue damper open
- raise the mantel to an acceptable height
- remove the mantel

### FLOOR CLEARANCES

- If installing appliance on the floor level, you must maintain the minimum distance of 14" to combustibles (see **Figure 8**).
- If combustible materials are less than 14" to the fireplace, you must install appliance at least 5" above the top surface of combustible flooring including tile and carpet (see **Figure 9**).



**Figure 8 - Minimum Fireplace Clearances If Installed at Floor Level**



**Figure 9 - Minimum Fireplace Clearances Above Combustible Flooring**

# INSTALLATION

## Continued

### INSTALLING DAMPER CLAMP ACCESSORY FOR VENTED OPERATION

*NOTE: When used as a vented appliance, appliance must be installed only in a solid-fuel-burning fireplace with a working flue and constructed of noncombustible material.*

**For Massachusetts Residents Only:** Installation of this gas log set as a vented appliance in the Commonwealth of Massachusetts requires the damper be permanently removed or welded in the fully open position.

If your appliance is a manually-controlled model, you may use this appliance as a vented product. There are three reasons for operating your appliance in the vented mode.

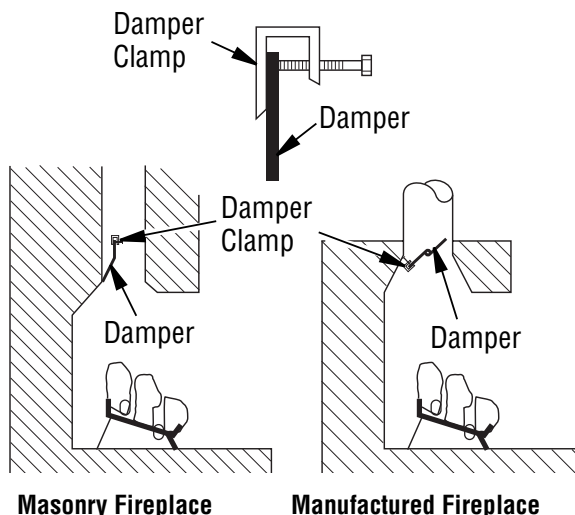
1. The fireplace does not meet the clearance to combustibles requirements for vent-free operation.
2. State or local codes do not permit vent-free operation.
3. You prefer vented operation.

If reasons number 1 or 2 above apply to you, you must permanently open chimney flue damper. You must install the damper clamp accessory (*to order, see Accessories, Page 40*). This will ensure vented operation (*see Figure 10*). The damper clamp will keep damper open. Installation instructions are included with clamp accessory.

See chart below for minimum permanent flue opening you must provide. Attach damper clamp so the minimum permanent flue opening will be maintained at all times.

Area of Various Standard Round Flues	
Diameter	Area
5"	20 sq. inches
6"	29 sq. inches
7"	39 sq. inches
8"	51 sq. inches

Chimney Height	Minimum Permanent Flue Opening
6' to 15'	39 sq. inches
15' to 30'	29 sq. inches



**Figure 10 - Attaching Damper Clamp**

### INSTALLING APPLIANCE BASE ASSEMBLY

**WARNING:** You must secure this heater to fireplace floor. If not, heater will move when you adjust controls. Moving heater may cause a gas leak or log misplacement.

**WARNING:** If installing in a sunken fireplace, special care is needed. You must raise the fireplace floor to allow access to heater control panel. This will ensure adequate air flow and guard against sooting and controls being damaged. Raise fireplace floor with noncombustible material. Make sure material is secure.

**CAUTION:** Do not pick up heater base assembly by burners. This could damage heater. Only handle base assembly by grates.

**IMPORTANT:** Make sure the heater burners are level. If appliance is not level, appliance will not work properly.

# INSTALLATION

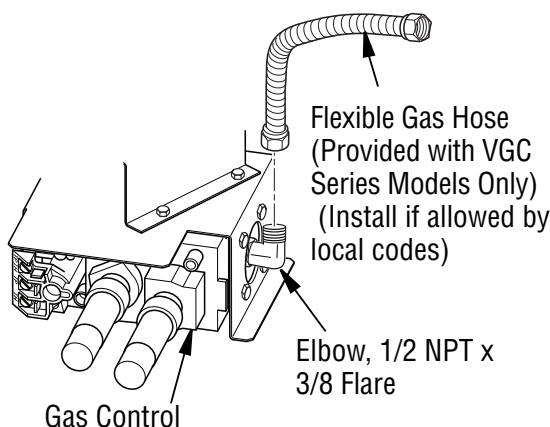
## Continued

### Installation Items Needed

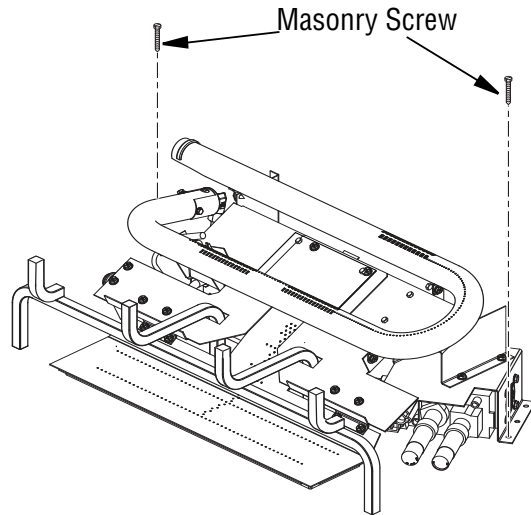
- hardware package (provided with appliance)
- approved flexible gas hose and fittings provided (if allowed by local codes)
- sealant (resistant to propane/LP gas, not provided)
- electric drill with 3/16" masonry drill bit

**NOTE:** Install optional MRC Series receiver and hand-held remote control kit (see *Accessories, Page 40*) before installing gas log appliance. See installation instructions included with the kit.

1. Apply pipe joint sealant lightly to male threads of the 1/2 NPT side of gas fitting elbow (provided) and connect to inlet side of gas control. Remove gas fitting from flexible gas hose (provided) before connecting to elbow (see *Figure 11*).
2. Position appliance base assembly in fireplace.
3. Mark screw locations through holes in front panel of base (see *Figure 12*). If installing in a brick-bottom fireplace, mark screw locations in mortar joint of bricks.
4. Remove appliance base from fireplace.
5. Drill holes at marked locations using 3/16" drill bit.
6. Attach base, through holes in back side panels of base, to fireplace floor using masonry screws provided in hardware package (see *Figure 12*).
7. Connect to gas supply. See *Connecting To Gas Supply*.



**Figure 11 - Attaching Flexible Gas Hose to Appliance Gas Regulator**



**Figure 12 - Attaching Base to Fireplace Floor**

### CONNECTING TO GAS SUPPLY

**WARNING:** This appliance requires a 3/8" NPT (National Pipe Thread) inlet connection to the pressure regulator.

**WARNING:** A qualified service person must connect appliance to gas supply. Follow all local codes.

**CAUTION:** Never connect propane/LP fireplace directly to the propane/LP supply. This heater requires an external regulator (not supplied). Install the external regulator between the heater and propane/LP supply.

**WARNING:** Never connect this appliance to private (non-utility) gas wells. This gas is commonly known as wellhead gas and does not have odorants and may have impurities, and variations in BTU content. The use of well-head gas will void the manufacturer's warranty to this appliance.

# INSTALLATION

## Continued

**CAUTION:** Use only new, black iron or steel pipe. Internally-tinned copper tubing may be used in certain areas. Check your local codes. Use pipe of 1/2" diameter or greater to allow proper gas volume to heater. If pipe is too small, undue loss of volume will occur.

**WARNING:** Use pipe joint sealant that is resistant to liquid petroleum (LP) gas.

### Installation Items Needed

Before installing appliance, make sure you have the items listed below.

- external regulator (supplied by installer)
- piping (check local codes)
- sealant (resistant to propane/LP gas)
- equipment shutoff valve \*
- test gauge connection \*
- sediment trap
- tee joint
- pipe wrench
- approved flexible gas line with gas connector (if allowed by local codes) (not provided)

\* An equipment shutoff valve with 1/8" NPT tap is an acceptable alternative to test gauge connection. Purchase the optional equipment shutoff valve from your dealer.

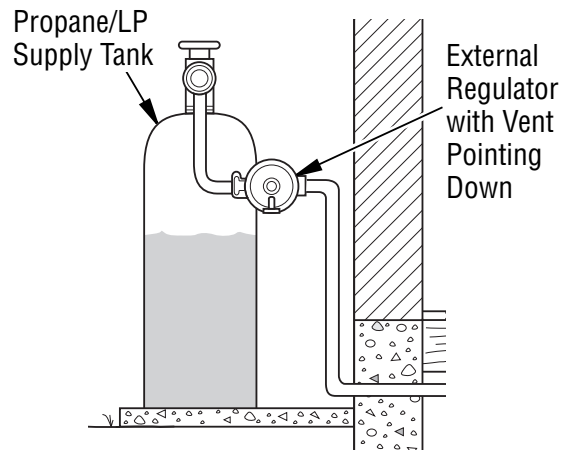
For propane/LP units, the installer must supply an external regulator. The external regulator will reduce incoming gas pressure. You must reduce incoming gas pressure to between 11" and 14" of water. If you do not reduce incoming gas pressure, appliance regulator damage could occur. Install external regulator with the vent pointing down as shown in **Figure 13**. Pointing the vent down protects it from freezing rain or sleet.

Installation must include an equipment shutoff valve, union and plugged 1/8" NPT tap. Locate NPT tap within reach for test gauge hook up. NPT tap must be upstream from appliance (see **Figure 14**).

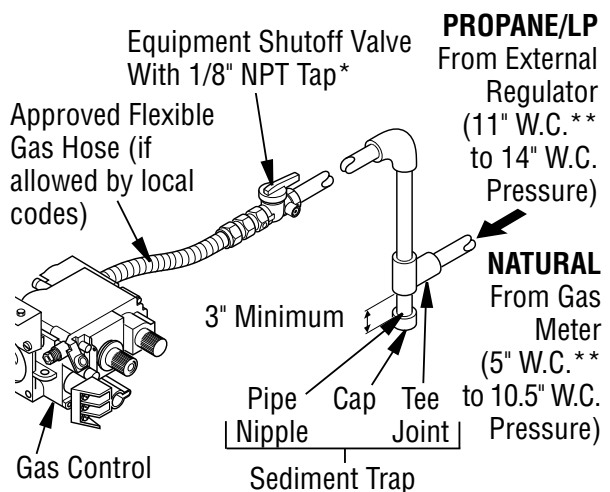
**IMPORTANT:** Install equipment shutoff valve in an accessible location. The equipment shutoff valve is for turning on or shutting off the gas to the appliance.

Check your building codes for any special requirements for locating equipment shutoff valve to appliances.

Apply pipe joint sealant lightly to male NPT threads. This will prevent excess sealant from going into pipe. Excess sealant in pipe could result in clogged appliance valves.



**Figure 13 - External Regulator With Vent Pointing Down**



\* Purchase the optional equipment shutoff valve from your dealer.

\*\* Minimum inlet pressure for purpose of input adjustment.

**Figure 14 - Gas Connection (Remote-Ready Models Only)**

We recommend that you install a sediment trap in supply line as shown in **Figure 14, Page 14**. Locate sediment trap where it is within reach for cleaning. Install in piping system between fuel supply and appliance. Locate sediment trap where trapped matter is not likely to freeze. A sediment trap traps moisture and contaminants. This keeps them from going into appliance controls. If sediment trap is not installed or is installed wrong, appliance may not run properly.



# INSTALLATION

## Continued

**⚠ CAUTION: Avoid damage to gas control. Hold gas control with wrench when connecting it to gas piping and/or fittings.**

### CHECKING GAS CONNECTIONS

**⚠ WARNING: Test all gas piping and connections, internal and external to unit, for leaks after installing or servicing. Correct all leaks at once.**

**⚠ WARNING: Never use an open flame to check for a leak. Apply a noncorrosive leak detection fluid to all joints. Bubbles forming show a leak. Correct all leaks at once.**

**⚠ CAUTION: Make sure external regulator has been installed between propane/LP supply and appliance. See guidelines under *Connecting to Gas Supply*, Page 13.**

### PRESSURE TESTING GAS SUPPLY PIPING SYSTEM

The appliance and its appliance main gas valve must be disconnected from the gas supply piping system during any pressure testing of that system at test pressures **in excess of** 1/2 psi (3.5 kPa).

The appliance must be isolated from the gas supply piping system by closing its equipment shutoff valve during any pressure testing of the gas supply piping system at test pressures **equal to or less than** 1/2 psi (3.5 kPa).

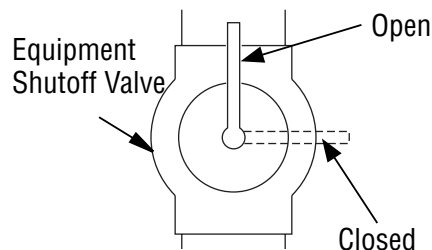
#### Test Pressures In Excess Of 1/2 PSIG (3.5 kPa)

1. Disconnect appliance with its appliance main gas valve (control valve) and equipment shutoff valve from gas supply piping system. Pressures in excess of 1/2 psig (3.5 kPa) will damage appliance regulator.
2. Cap off open end of gas pipe where equipment shutoff valve was connected.

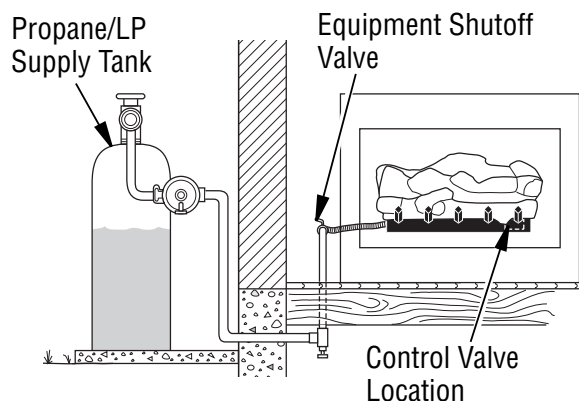
3. Pressurize supply piping system by either opening propane/LP supply tank valve for propane/LP gas or opening main gas valve located on or near gas meter for natural gas or using compressed air.
4. Check all joints of gas supply piping system. Apply noncorrosive leak detection fluid to all joints. Bubbles forming show a leak.
5. Correct all leaks at once.
6. Reconnect appliance and equipment shutoff valve to gas supply. Check reconnected fittings for leaks.

#### Test Pressures Equal To or Less Than 1/2 PSIG (3.5 kPa)

1. Close equipment shutoff valve (see *Figure 15*).
2. Pressurize supply piping system by either opening propane/LP supply tank valve for propane/LP gas or opening main gas valve located on or near gas meter for natural gas or using compressed air.
3. Check all joints from gas meter to equipment shutoff valve for natural gas or propane/LP supply to equipment shutoff valve for propane/LP (see *Figure 16* or *Figure 17*, Page 16). Apply noncorrosive leak detection fluid to all joints. Bubbles forming show a leak.
4. Correct all leaks at once.



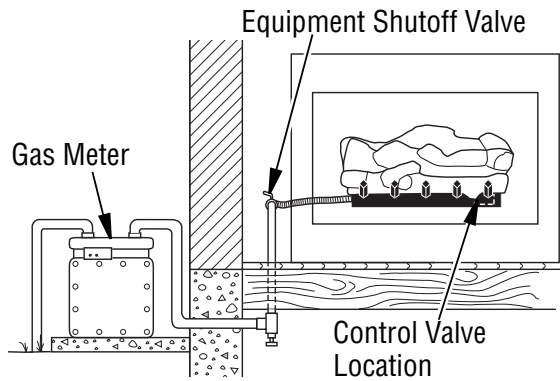
**Figure 15 - Equipment Shutoff Valve**



**Figure 16 - Checking Gas Joints (Propane/LP Only)**

# INSTALLATION

## Continued



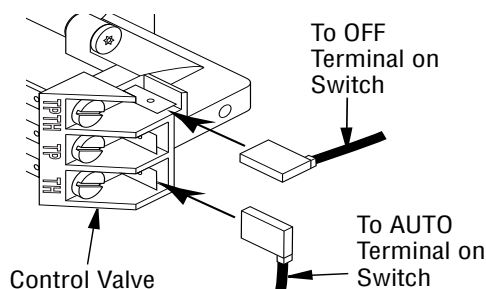
**Figure 17 - Checking Gas Joints (Natural Gas Only)**

### PRESSURE TESTING APPLIANCE GAS CONNECTIONS

1. Open equipment shutoff valve (see [Figure 15, Page 15](#)).
2. Open main gas valve located on or near gas meter for natural gas or open propane/LP supply tank valve.
3. Make sure control knob of appliance is in the OFF position.
4. Check all joints from gas meter to equipment shutoff valve for natural gas or propane/LP supply to equipment shutoff valve for propane/LP (see [Figure 16, Page 15](#) or [Figure 17, Page 16](#)). Apply noncorrosive leak detection fluid to all joints. Bubbles forming show a leak.
5. Correct all leaks at once.
6. Light appliance (see [Operation, Page 23](#)). Check all other internal joints for leaks.
7. Turn off appliance (see [To Turn Off Gas to Appliance, Page 25](#) for Remote Ready models or [Page 27](#) for Variable Remote Models).

### INSTALLING SWITCH (REMOTE READY MODELS)

The AUTO/OFF/ON switch for this log set is installed into the small single log accompanying this log set. This switch needs to be used only if remote or wall switch is not being used.



**Figure 18 - Connecting Wires**

Connect the wires to the valve from the switch assembly as shown in [Figure 18](#).

### INSTALLING OPTIONAL REMOTE ACCESSORIES (REMOTE READY MODELS)

#### Installing Remote Receiver

Remote control accessories are available separately (see [Accessories, Page 40](#)). Read instructions shipped with remote control along with instructions below before attempting installation.

1. If unit is already installed in fireplace, continue with these instructions. If unit has not been installed in fireplace, go to step 6 and continue installation of remote accessory.

**WARNING:** Turn off appliance and let cool before handling any part of appliance. Make sure gas is turned off to unit.

2. Carefully remove logs and set aside.
3. Locate mounting screws on sides of appliance base assembly and remove screws. Set screws aside for reinstallation.
4. Disconnect gas line from appliance base as shown in [Figure 11, Page 13](#).

**WARNING:** A qualified service person must connect and disconnect gas to appliance. Follow all local codes.

5. Remove appliance base from fireplace.
6. If installed, disconnect AUTO/OFF/ON switch wire from control valve at TPTH and TH locations (see [Figure 19](#)).
7. Connect wires from hardware pack (with remote receiver bracket) to control valve at the TPTH and TH locations as shown in [Figure 19](#). Connect other ends of these wires to remote receiver wires.

**NOTE:** Make sure excess wire does not interfere with burner or pilot.

8. If appliance was removed from fireplace before installation of remote accessory, see [Installing Appliance Base Assembly on Page 12](#) to reinstall appliance into fireplace. Test gas connection for leaks (see [Checking Gas Connections, Page 15](#)).



## INSTALLATION

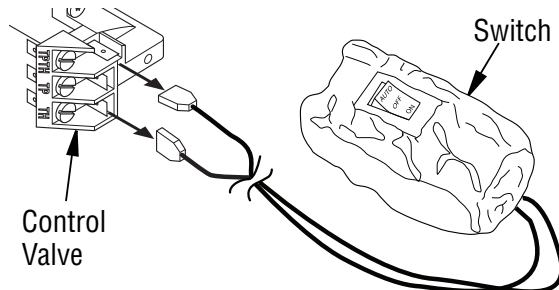
### Continued

- If logs were removed from appliance for install remote accessory, replace logs (see *Installing Logs, Embers and Volcanic Stone, Page 18*).
- Place remote receiver on fireplace floor next to control valve. Make sure the remote receiver and wires are not on or touching either gas burner on the log set.

### Installing Batteries for Remote Receiver and Hand Held Remote Control

Two 9-volt alkaline batteries (not included) are required to operate this appliance with the wireless hand-held remote control set. One battery must be installed in the receiver and one in the hand-held remote control unit.

**NOTE:** Only use alkaline batteries.



**Figure 19- Disconnecting Switch from Control Valve (Remote Ready Models Only)**

### INSTALLING BATTERIES IN REMOTE CONTROL AND RECEIVER (VARIABLE REMOTE MODELS)

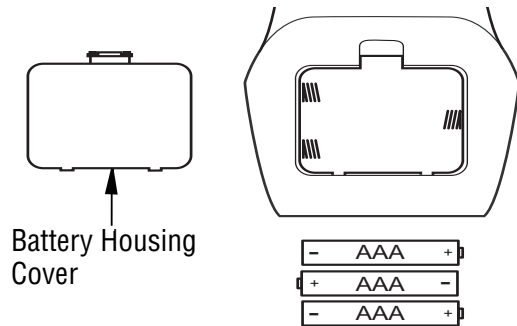
**WARNING:** Make sure your selector switch is in OFF position before installing or changing batteries in your hand-held remote or receiver.

#### Hand-Held Remote Control

The hand-held remote control uses 3 AAA batteries (not included).

To install batteries:

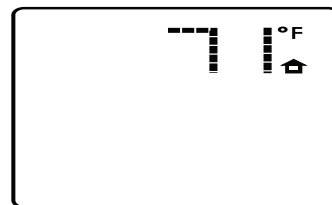
- Remove battery housing cover from back of hand-held remote (see **Figure 20**).
- Install or replace batteries.



**Figure 20 - Battery Install Hand-Held Remote Control**

- Replace battery housing cover.

When batteries are installed, the "little house" icon with current room temperature will be displayed (see **Figure 21**). This icon will always show in the control window as long as the batteries have power.

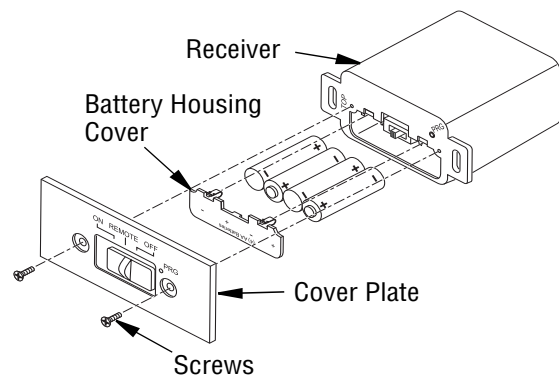


**Figure 21 - Remote Display**

#### Remote Receiver

The remote receiver uses 4 AA batteries (not included). To install or replace batteries:

- Open lower louver to gain access to receiver.
- Remove screws from cover plate.
- Remove battery housing cover.
- Install or replace batteries.
- Replace battery housing cover.
- Replace cover plate.



**Figure 22 - Battery Install Remote Control Receiver**

# INSTALLATION

## Continued

### Magniflame SERIES BURNER SYSTEM-LOG COMPATIBILITY CHART

Burner System Model	Refractory Concrete Logs For Use With This Burner System
MAGNIFLAME24MN MAGNIFLAME24VN MAGNIFLAME24MP MAGNIFLAME24VP	SOUTHERNCOMFORT24A/B SOUTHERNCOMFORT30A/B SHADYHOLLOW24A/B SHADYHOLLOW30A/B
MAGNIFLAME30MN MAGNIFLAME30VN MAGNIFLAME30MP MAGNIFLAME30VP	SOUTHERNCOMFORT36A/B SHADYHOLLOW36A/B

Figure 23 - Log Compatibility Chart

### INSTALLING LOGS, EMBERS AND VOLCANIC STONE

**WARNING:** Failure to position the parts in accordance with these diagrams or failure to use only parts specifically approved with this appliance may result in property damage or personal injury.

**WARNING:** After installation and periodically thereafter, check to ensure that no flame comes in contact with any log. With appliance set to Hi, check to see if flames contact any log. If so, reposition logs according to log installation instructions in this manual. Flames contacting logs will create soot.

#### LOG PLACEMENT

It is very important to install these logs exactly as instructed. Do not modify logs. Only use logs, as identified for use with the appliance as shown in **Figure 23**.

**NOTE:** Each log includes an identifying number cast in the log. Look at each log when placing them on the burner system to be certain it is correct.

1. Find the right front log (SouthernComfort24A/B or ShadyHollow24A/B models: D-061, SouthernComfort30A/B or ShadyHollow30A/B models: D-019, SouthernComfort36A/B or ShadyHollow36A/B models: D-027). See **Figures 24, 24A, 24B, and 24C** for reference.

The log has a rectangular shape on the bottom that fits against the lip on the black metal base, the square grate, and the round tube burner. Slide the log in place as shown in Figures.

2. Find the back left log SouthernComfort24A/B or ShadyHollow24A/B models: D-060, SouthernComfort30A/B or ShadyHollow30A/B models: D-018, SouthernComfort36A/B or ShadyHollow36A/B models: D-026). See **Figures 25, 25A, and 25B**. **Figure 25A** shows how the log must fit against the end of the burner.

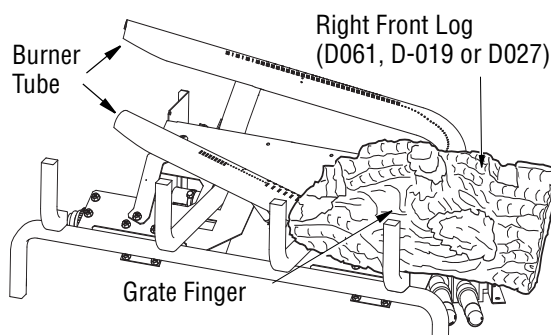


Figure 24 - Installing Right Front Log

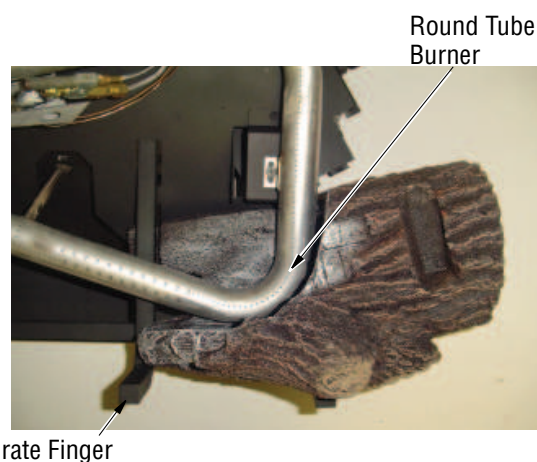


Figure 24A - Installing Right Front Log, Top View

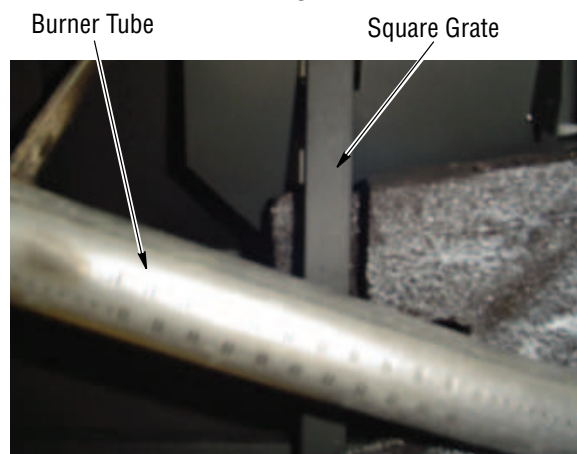
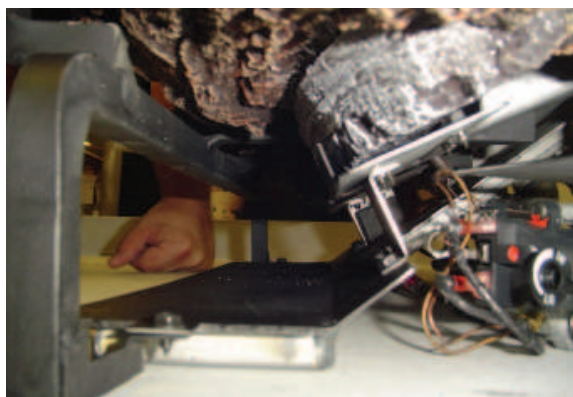


Figure 24B - Installing Right Front Log, Top View

# INSTALLATION

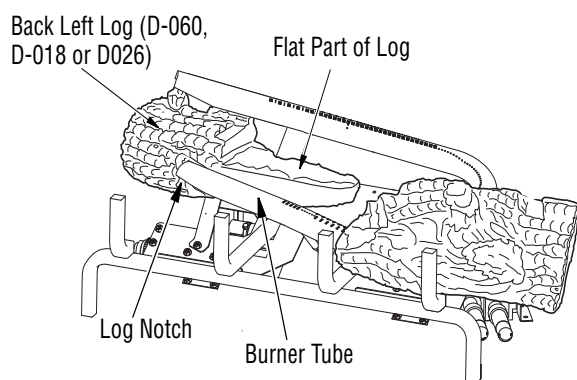
## Continued



**Figure 24C - Installing Right Front Log, Side View**

**Figure 25B** shows how the notch in log fits against the vertical portion of the burner tube. Place this log on the base assembly by inserting it from the left side as shown in **Figure 25**. You will need to twist the log slightly to get it to fit against the burners properly. It will rest even with the back edge of the pan.

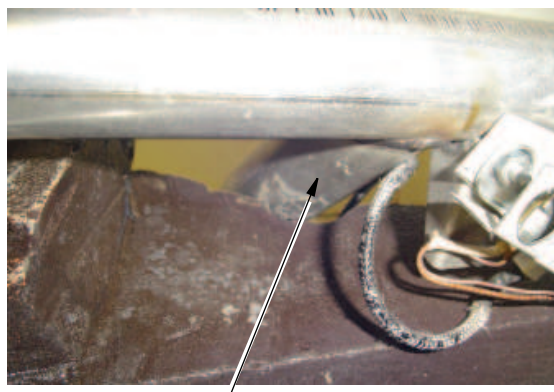
- Find the front left log (SouthernComfort24A/B or ShadyHollow24A/B models: D-059, SouthernComfort30A/B or ShadyHollow30A/B models: D-017, SouthernComfort36A/B or ShadyHollow36A/B models: D-025). See **Figures 26, 26A, and 26B**. The log has a rectangular stand off on the bottom that fits against the lip on the black metal base as shown in **Figure 26A**.



**Figure 25 - Installing Back Left Log**



**Figure 25A - Installing Back Left Log**

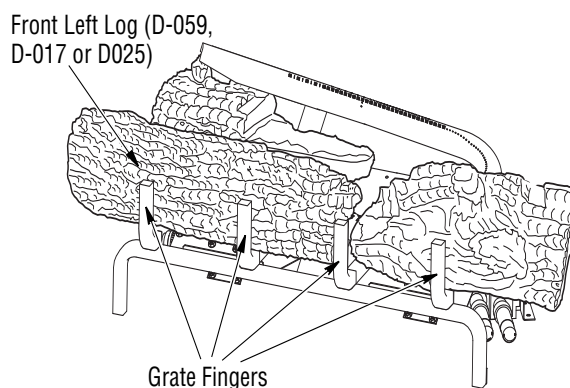


Vertical Portion of Burner Tube

**Figure 25B - Installing Back Left Log (D-018) Rear View**

The bottom of this log has a slot that fits over the second bar on the grate as shown in **Figure 26B, Page 20**. Place the log on the base assembly as shown in figures.

- Find the charred log (D-020). See **Figures 27, 27A, and 27B**. The log has a slot in the bottom that fits over the square grate and rests against the burner tube as shown in **Figure 27**. Place this log on the base as shown in figures.



**Figure 26 - Installing Front Left Log**

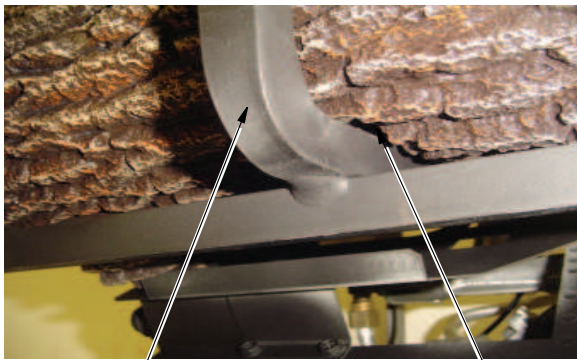


**Figure 26A - Installing Front Left Log Side View**



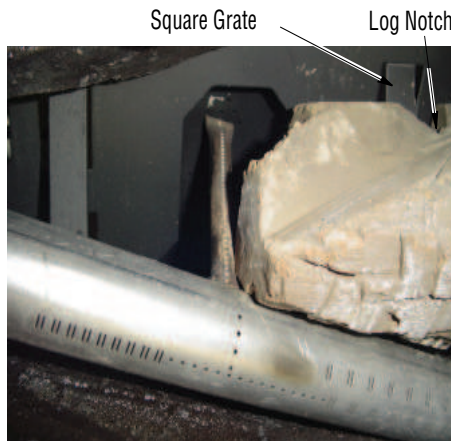
# INSTALLATION

*Continued*



Grate Finger                      Log Slot

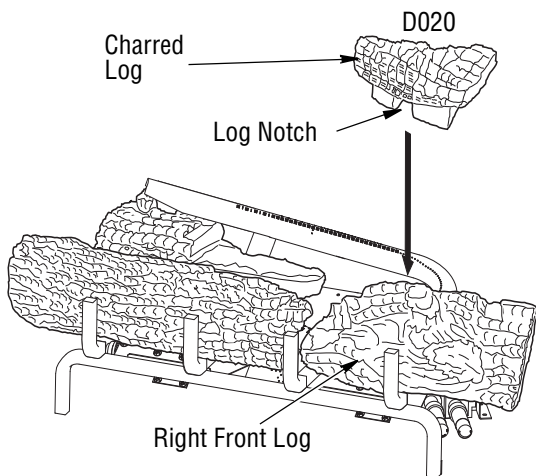
**Figure 26B - Installing Front Left Log**



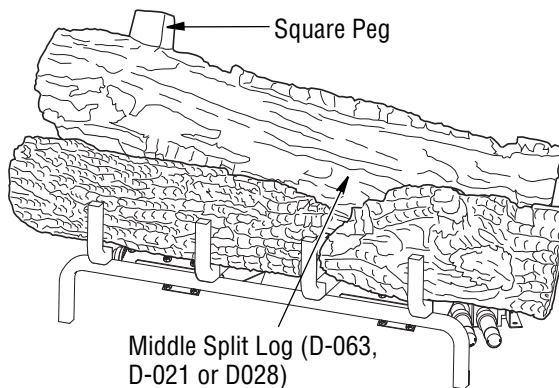
**Figure 27B - Installing Charred Log Top Side View**

- Find the middle split log (SouthernComfort24A/B or ShadyHollow24A/B models: D-063, SouthernComfort30A/B or ShadyHollow30A/B models: D-021, SouthernComfort36A/B or ShadyHollow36A/B models: D-028). See **Figures 28 and 28A**. The split side of the log faces forward. The log has a notch that fits around the burner tube on the right side.

- The left side of the burner tube fits into the notch on the back side of this log. The log is placed properly when it sits parallel to the tube burner and the square peg is pointing up. See figures for reference.
- Find the right split crossover log (D-022). The bottom of the log has a rectangular stand off that fits in the slots on the right side of the front right log and the middle split log. Place this log as shown in **Figure 29**.



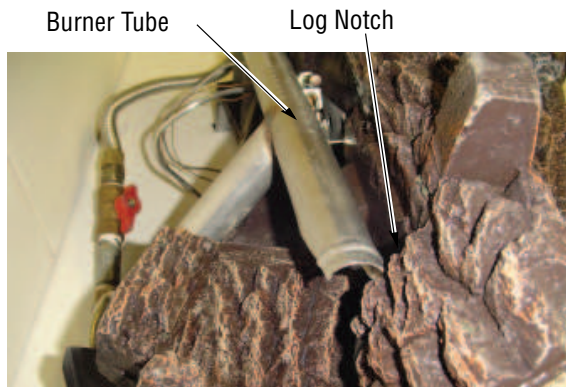
**Figure 27 - Installing Charred Log**



**Figure 28 - Installing Middle Split Log (D-021)**

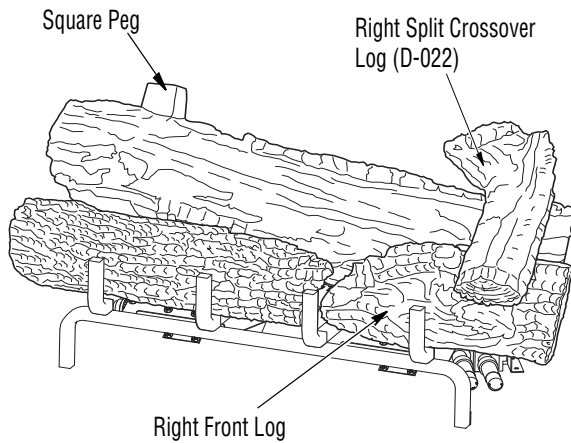


**Figure 27A - Installing Charred Log Top View**



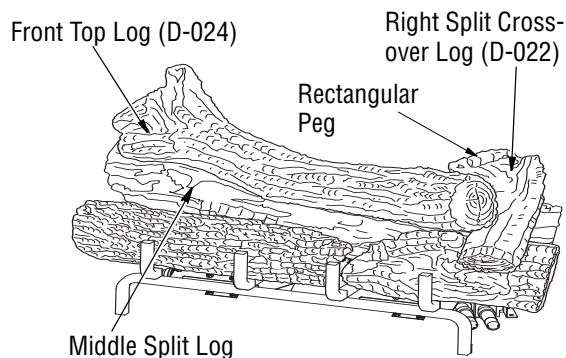
**Figure 28A - Installing Middle Split Log Rear Top Side View**

## INSTALLATION Continued



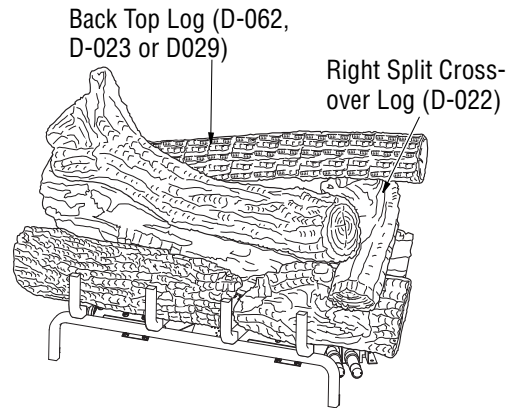
**Figure 29 - Installing Right Split Crossover Log**

7. For SouthernComfort, find the front top log (D-024). See **Figure 30**. The left end of this log has a square hole that fits over a square peg that is on the top of the middle split log. The right end of this log rests behind the knot on the top of the front right log.



**Figure 30 - Installing Large Middle Log**

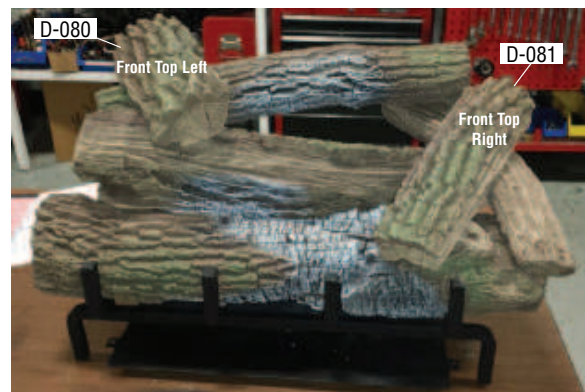
8. Find the back top log (SouthernComfort24A/B or ShadyHollow24A/B models: D-062, SouthernComfort30A/B or ShadyHollow30A/B models: D-023, SouthernComfort36A/B or ShadyHollow36A/B models: D-029). See **Figures 31, and 31A**. The left end of this log has a round hole that fits over the round peg that is on the top of the back left log. The right end of this log has a rectangular hole that fits over the rectangular peg on the top of the right crossover log.



**Figure 31 - Installing Back Top Log and Final Assembly**



**Figure 31A - Installing Back Top Log, Top View**



**Figure 32 - Installing Small Left Hand And Right Hand Logs**

**For ShadyHollow logs only, follow steps 9 and 10.**

9. Install the small Left Top Log D080 as shown in **Figure 32** by mating the rectangular peg and notch.
10. Install the small Right Top Log D081 as shown in **Figure 32**.



# INSTALLATION

*Continued*

## EMBER PLACEMENT

Two ember materials are supplied with this log set. Platinum Bright Embers give a bright glow appearing as hot coals. Should embers need replacing, see *Accessories, Page 40*.

- **Platinum Bright Ember placement.** Add embers to front, flat burner. Gently remove embers from bag. Separate pieces of ember material and place on surface of flat burner just behind horizontal ports as shown in *Figure 33*.

**⚠ WARNING: Do not use any other ember material not supplied with this unit.**

**⚠ WARNING: Do not operate unit without ember material correctly in place as shown in *Figures 33 and 34*. Do NOT place ember material anywhere else on the unit. Use only ember material supplied with unit. Excessive or incorrectly placed ember material may produce carbon monoxide or soot. If replacement embers are needed, the replacement embers must be purchased from IHP. See *Page 40* for part numbers.**

**⚠ WARNING: ALL PREVIOUSLY APPLIED LOOSE MATERIAL MUST BE REMOVED PRIOR TO REAPPLICATION.**

## VOLCANIC STONE PLACEMENT

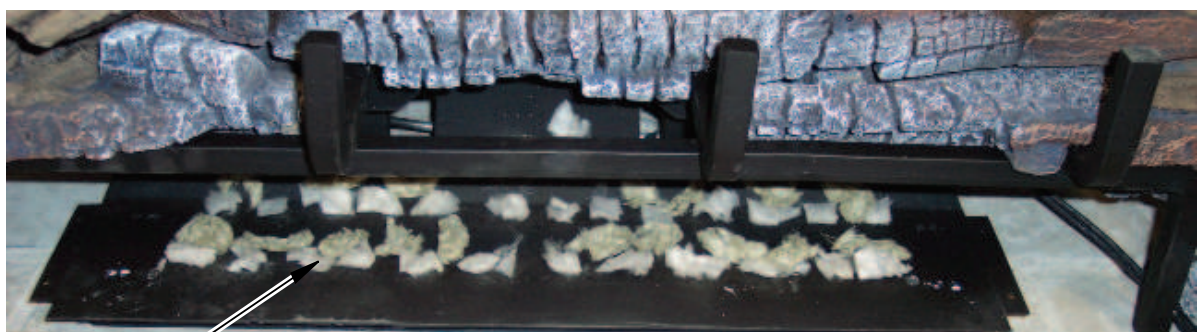
- **Glowing Embers placement.** Place glowing embers material on front flat burner in areas away from ports as shown in *Figure 34*.
- Add Volcanic Stone; Volcanic Stone may cover 1/2 inch of the front burner (flat metal ember pan burner) but shall not be allowed to come in contact with either the burner ports or flame around base of appliance if desired. **DO NOT place rock or additional logs on front burner or on logs except as directed above.** Placing any material on unit other than ember material on front burner may result in production of carbon monoxide or soot. A switch log is included with each log set. This log is designed to house a switch on remote ready models. On variable remote models, this switch is not needed. The log can be placed on the floor of the fireplace to enhance the look of the log set. Use Volcanic Stone to hide wires from switch/log to control valve. Place switch/log so the switch is easy to access.



Ember Material

*Figure 33 - Platinum Bright Embers*

Flat Front Burner




Glowing Embers (rockwool)

*Figure 34 - Placement of Glowing Embers (shown with Platinum Bright Embers)*

# OPERATION


## REMOTE READY MODELS OPERATION

FOR YOUR SAFETY  
READ BEFORE LIGHTING

 **WARNING:** If you do not follow these instructions exactly, a fire or explosion may result causing property damage, personal injury or loss of life.

- A. This appliance has a pilot which must be lighted by hand. When lighting the pilot, follow these instructions exactly.
- B. **BEFORE LIGHTING** smell all around the appliance area for gas. Be sure to smell next to the floor because some gas is heavier than air and will settle on the floor.
- WHAT TO DO IF YOU SMELL GAS**
- Do not try to light any appliance.
  - Do not touch any electric switch; do not use any phone in your building.
  - Immediately call your gas supplier from a neighbor's phone. Follow the gas supplier's instructions.
  - If you cannot reach your gas supplier, call the fire department.
- C. Use only your hand to push in or turn the gas control knob. Never use tools. If the knob will not push in or turn by hand, don't try to repair it, call a qualified service technician or gas supplier. Force or attempted repair may result in a fire or explosion.
- D. Do not use this appliance if any part has been under water. Immediately call a qualified service technician to inspect the appliance and to replace any part of the control system and any gas control which has been under water.


## LIGHTING INSTRUCTIONS

-  **WARNING:**
- If fireplace has glass doors, never operate this appliance with glass doors closed. If you operate appliance with doors closed, heat buildup inside fireplace will cause glass to burst. Make sure there are no obstructions across openings of fireplace.
  - You must operate this appliance with a fireplace screen in place. Make sure fireplace screen is closed before running appliance.

**NOTICE:** During initial operation of new appliance, burning logs will give off a paper-burning smell. Orange flame will also be present. Open damper or window to vent smell. This will only last a few hours.


***NOTE:** Homeowners generally prefer to operate their appliance with the chimney damper closed. This will put all the heat into the room. However, there may be times you will desire the full flames of the HI heat setting but will find the heat output excessive. You can open the chimney damper (if you have one) fully or partially to release some of the heat.*

 **WARNING:** Damper handle will be hot if appliance has been running.

1. STOP! Read the safety information, column 1.
2. Make sure equipment shutoff valve is fully open.
3. Set switch to OFF position.
4. Press in and turn control knob clockwise  to the OFF position (see **Figure 35, Page 24**).
5. Wait five (5) minutes to clear out any gas. Then smell for gas, including near the floor. If you smell gas, STOP! Follow "B" in the safety information, column 1. If you don't smell gas, go to the next step.

## REMOTE READY MODELS OPERATION

### Continued

- Press in and turn control knob counterclockwise  to the PILOT position. Press in control knob for five (5) seconds (see **Figure 35**).

**NOTE:** You may be running this appliance for the first time after hooking up to gas supply. If so, the control knob may need to be pressed in for 30 seconds or more. This will allow air to bleed from the gas system.


- With control knob pressed in, press and release igniter button on left side of log set. This will light pilot. The pilot is attached to the front of U-shaped burner. If needed, keep pressing igniter button until pilot lights.

**NOTE:** If pilot does not stay lit, contact a qualified service person or gas supplier for repairs. Until repairs are made, light pilot with match. To light pilot with match, see Manual Lighting Procedure, Page 25.

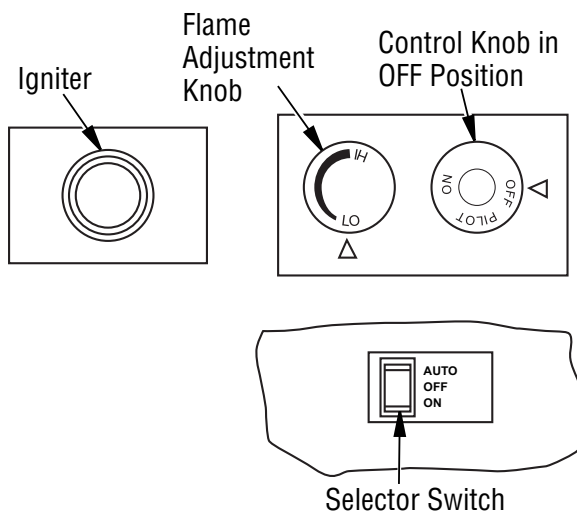
- Keep control knob pressed in for 30 seconds after lighting pilot. After 30 seconds, release control knob.

- If control knob does not pop out when released, contact a qualified service person or gas supplier for repairs.

**NOTE:** If pilot goes out, repeat steps 4 through 8.


- Slightly push in and turn control knob counterclockwise  to the ON position. If using a hand-held remote control accessory, go to Optional Hand-Held Remote Operation on Page 25.

- Wait one minute and put switch in ON position to light burners.



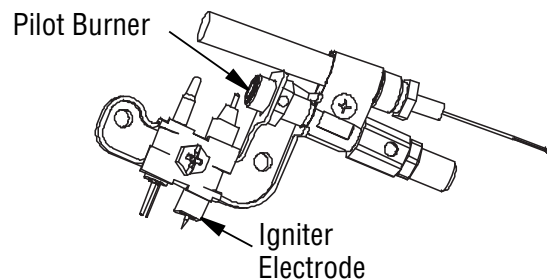
**Figure 35 - Control Knob, Igniter Button and AUTO/OFF/ON Switch**

**NOTE:** AUTO is only functional when using GWMT1 or GWMS2 optional accessories. If hand-held remote control is installed but not being used, slide remote selector switch to ON (It must be in this position for burners to light. Switch will be in REMOTE position if using hand-held remote).

- Set flame adjustment knob to any level between HI and LO.
- To leave pilot lit and shut off burners only: turn control knob clockwise  to the PILOT position, or use remote control manual OFF button, or set selector switch in the OFF position.

**CAUTION:** Do not try to adjust heating levels by using the equipment shutoff valve.

**WARNING:** Make sure the remote selector switch is in the OFF position when you are away from home for long periods of time. Appliance will come on automatically with selector switch in the ON position.




**Figure 36 - Pilot (Natural)**



## REMOTE READY MODELS OPERATION *Continued*

### TO TURN OFF GAS TO APPLIANCE

1. Turn control knob clockwise  to the OFF position.
- 2a. Set switch in the OFF position.
- 2b. **If Using Optional Hand-Held Remote:** Set selector switch in the OFF position to prevent draining battery.
3. Close equipment shutoff valve (see *Figure 15, Page 15*).

### MANUAL LIGHTING PROCEDURE

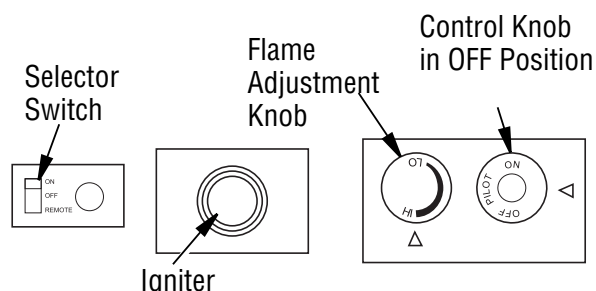
1. Follow steps 1 through 6 under *Lighting Instructions, Page 23*.
2. Press control knob and light pilot with match.
3. Keep control knob pressed in for 30 seconds after lighting pilot. After 30 seconds, release control knob. Now follow steps 9 through 11, *Lighting Instructions, Page 23*.

### OPTIONAL HAND-HELD REMOTE OPERATION

**NOTE:** All remote control accessories must be purchased separately (see *Accessories, Page 40*). Follow instructions included with the remote control.

**NOTICE:** You must light the pilot before using the hand-held remote control unit. See *Lighting Instructions on Page 23*.

After lighting, let pilot flame burn for about one minute. Turn control knob to ON position. Adjust flame adjustment knob anywhere between HI and LO. Slide the selector switch to the REMOTE position (see *Figure 37*).



**Figure 37 - Control Knob, Igniter Button and Remote Selector Switch**

**NOTE:** The burner may light if hand-held remote was on when selector switch was last turned off. You can now turn burner on and off with hand-held remote control unit.

**IMPORTANT:** Do not leave selector switch in the REMOTE or ON position when pilot is not lit. This will drain the battery.

**NOTE:** Do not hold hand-held remote for a long time. Body temperature will affect its operation in the AUTO mode.

## VARIABLE REMOTE MODELS OPERATION

### FOR YOUR SAFETY READ BEFORE LIGHTING

**WARNING:** If you do not follow these instructions exactly, a fire or explosion may result causing property damage, personal injury or loss of life.

- A. This appliance has a pilot which must be lighted by hand. When lighting the pilot, follow these instructions exactly.
- B. **BEFORE LIGHTING** smell all around the appliance area for gas. Be sure to smell next to the floor because some gas is heavier than air and will settle on the floor.  
**WHAT TO DO IF YOU SMELL GAS**
  - Do not try to light any appliance.
  - Do not touch any electric switch; do not use any phone in your building.
  - Immediately call your gas supplier from a neighbor's phone. Follow the gas supplier's instructions.
  - If you cannot reach your gas supplier, call the fire department.
- C. Use only your hand to push in or turn the gas control knob. Never use tools. If the knob will not push in or turn by hand, don't try to repair it, call a qualified service technician or gas supplier. Force or attempted repair may result in a fire or explosion.
- D. Do not use this appliance if any part has been under water. Immediately call a qualified service technician to inspect the appliance and to replace any part of the control system and any gas control which has been under water.

## VARIABLE REMOTE MODELS OPERATION



*Continued*

### LIGHTING INSTRUCTIONS

**⚠ NOTICE:** During initial operation of new fireplace, burning logs will give off a paper-burning smell. Open damper or window to vent smell. This will only last a few hours.

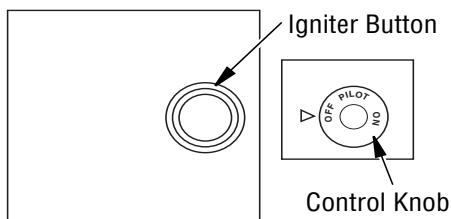
1. STOP! Read the safety information, column 1.
2. Make sure equipment shutoff valve is fully open.
3. Set remote selector switch in OFF position.

**⚠ WARNING:** Burners will come on automatically within one minute when the selector switch is in the ON position after the pilot is lit.

4. Press in and turn control knob clockwise  to the OFF position.
5. Wait five (5) minutes to clear out any gas. Then smell for gas, including near the floor. If you smell gas, STOP! Follow "B" in the safety information, column 1. If you don't smell gas, go to the next step.
6. Press in and turn control knob counterclockwise  to the PILOT position. Press in control knob for five (5) seconds (see **Figure 38**).

**NOTE:** You may be running this appliance for the first time after hooking up to gas supply. If so, the control knob may need to be pressed in for 30 seconds or more. This will allow air to bleed from the gas system.



**⚠ CAUTION:** Do not try to adjust heating levels by using the equipment shutoff valve.



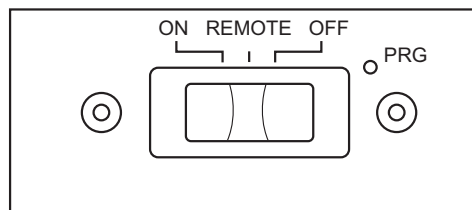
**Figure 38 - Control Knob and Igniter Button Location**

7. With control knob pressed in, press and release igniter button. This will light pilot. The pilot is attached to the front burner. If needed, keep igniter button pressed in until pilot lights.

**NOTE:** If pilot does not stay lit, contact a qualified service person or gas supplier for repairs. Until repairs are made, light pilot with match. To light pilot with match, see *Manual Lighting Procedure*, **Page 27**.

8. Keep control knob pressed in for 30 seconds after lighting pilot. After 30 seconds, release control knob.
  - If control knob does not pop out when released, contact a qualified service person or gas supplier for repairs.
9. Slightly push in and turn control knob counterclockwise  to the ON position.
10. Wait one minute and switch selector switch to the ON position to light burners (see **Figure 39**). When using in the ON position (without remote) burners will light on high. There is no adjustment to the flames without using remote.
11. To leave pilot lit and shut off burners only, turn control knob clockwise  to the PILOT position, or use remote control manual OFF button, or set selector switch in the OFF position.

**⚠ WARNING:** Make sure the selector switch is in the OFF position when you are away from home for long periods of time. Appliance will come on automatically with selector switch in the ON position.



**Figure 39 - Remote Selector Switch in ON Position**

# VARIABLE REMOTE MODELS OPERATION

Continued

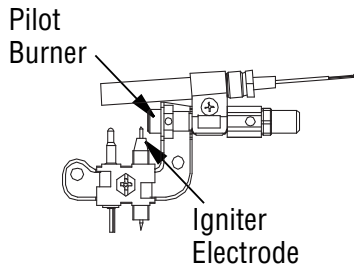



Figure 40 - Pilot (Natural/ Propane/LP)

## TO TURN OFF GAS TO APPLIANCE

1. Turn control knob clockwise  to the OFF position.
2. Set selector switch in the OFF position.
3. Close equipment shutoff valve (see **Figure 15, Page 15**).

## MANUAL LIGHTING PROCEDURE

1. Follow steps 1 through 6 under Lighting Instructions, **Page 26**.
2. Depress control knob and light pilot with match.
3. Keep control knob pressed in for 30 seconds after lighting pilot. After 30 seconds, release control knob. Now follow steps 9 through 11 under Lighting Instructions, **Page 26**.

## BLOWER OPERATION

**⚠ WARNING:** This fireplace has a three-prong, grounded electrical plug. This plug helps protect you against electrical shock. Only connect plug to a properly grounded, three-prong receptacle. Do not cut or remove the grounding prong from this plug.

Locate the blower switch by opening lower louver on fireplace. Blower switch is located at lower center inside louver door.

**NOTE:** It is safe to operate fireplace with blower turned off. However, the blower helps distribute heated air from the fireplace.

**NOTE:** Periodically check the louvers of the firebox and remove any dust, dirt or other obstructions.

## HAND-HELD REMOTE OPERATION

### BATTERIES

**⚠ WARNING:** Make sure your selector switch is in OFF position before installing or changing batteries in your hand-held remote or receiver.

For installing or replacing batteries in remote control or receiver, see Installing Batteries in Remote Control and Receiver on **Page 17**.

### Low Battery - Hand-Held Remote Control

When batteries in hand-held remote control are low, an icon will appear on display.

### Low Battery - Remote Receiver

When batteries in receiver are low, no acoustic signal will be given when ON/OFF button is pressed. If batteries in receiver are low, fireplace can be switched on manually by moving remote selector switch to ON (see **Figure 41**).

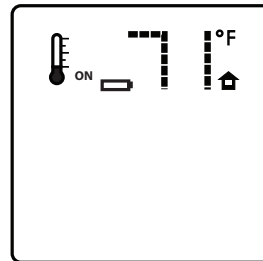


Figure 41 - Low Battery Display

### FAHRENHEIT/CELSIUS INDICATOR

You can set your hand-held remote control to display the temperature in either Fahrenheit or Celsius. With remote control off, press THERMOSTAT button and MODE button at the same time. This will toggle the display from °F to °C.

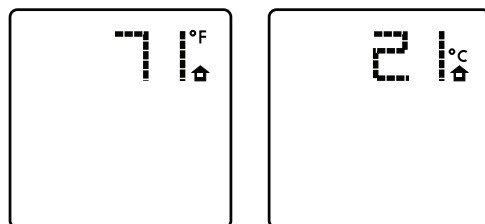


Figure 42 - Remote Control Display Fahrenheit to Celsius

# VARIABLE REMOTE MODELS OPERATION

Continued

## OPERATING REMOTE CONTROL

**WARNING:** Fireplace can turn on suddenly. Keep away from burner.

After lighting pilot, let pilot flame burn for about one minute. Slide remote selector switch to REMOTE position. You can now turn burner on and off with remote.

**IMPORTANT:** Do not leave selector switch in REMOTE or ON position when pilot is not lit. This will drain batteries.

When any button is pushed on remote control, LCD display will glow blue. Blue glow will go off after several seconds if no action is being taken with remote.

### ON/OFF

Push ON/OFF button and burners will come on in high position (see Figure 43). An acoustic signal from the receiver confirms the command.

Push ON/OFF button again and burners will turn off. A beep from receiver confirms the command.

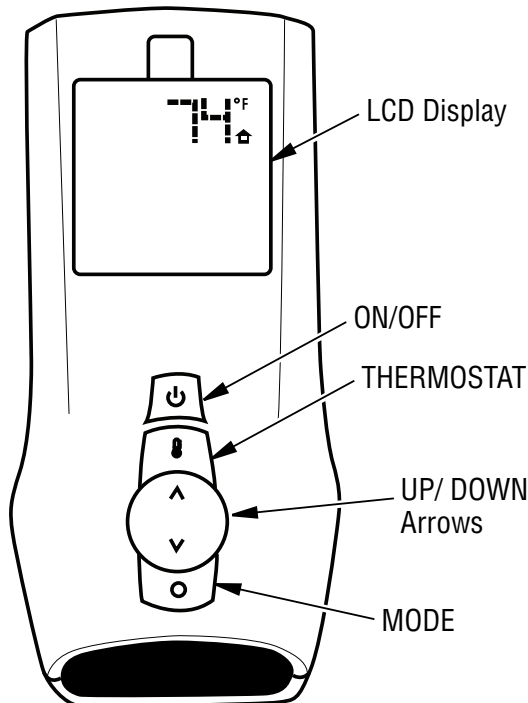


Figure 43 - Hand-Held Remote Control

## FLAME HEIGHT

This function allows you to control height of flames through 5 levels (see Figure 44). Select manual flame height function by pressing MODE button until a flame is shown in lower left corner of display. Use UP/DOWN arrow button to set desired flame height (see Figure 43). A beep from receiver confirms the command.

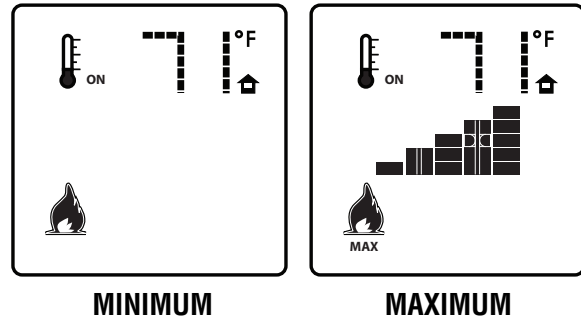


Figure 44 - Remote Control Display of Flame Height Minimum and Maximum

## ROOM THERMOSTAT

The remote control can operate as a room thermostat. The thermostat can be set to a desired temperature to control the comfort level in the room.

To activate, press THERMOSTAT button on remote control (see Figure 43). The word ON will appear to the right of temperature bulb graphic on display (see Figure 45). Use UP/DOWN arrow button to set desired room temperature. Control system will cycle fireplace on or off to maintain selected temperature.

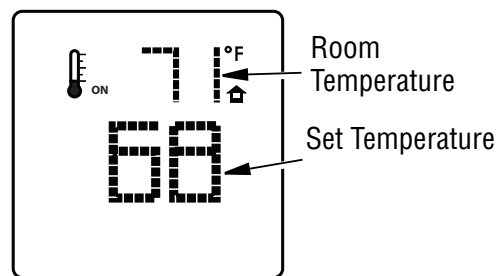


Figure 45 - Room Temperature Setting

## SMART THERMOSTAT

The Smart Thermostat adjusts flame height in accordance to differences between set temperature and room temperature. As room temperature gets closer to set temperature the smart function will modulate the flame lower. As room temperature cools, it will modulate the flame higher.

# VARIABLE REMOTE MODELS OPERATION

Continued

To activate this function, press THERMOSTAT button until the word SMART appears to the right of temperature bulb graphic on display. Use UP/DOWN arrow button to set desired room temperature. The control system will cycle the fireplace on or off to maintain selected temperature.

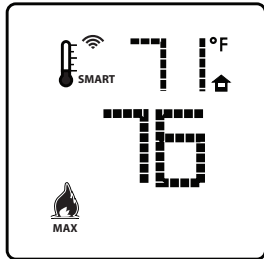


Figure 46 - Smart Thermostat Setting

## CHILD SAFETY LOCK-OUT

This function lets you deactivate the remote control buttons. It is active when the lock icon is lit on the display.

To activate, press MODE button and UP arrow button at the same time. To deactivate, press again.

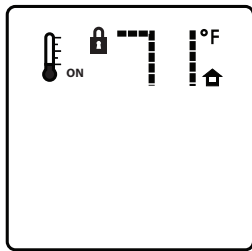


Figure 47 - Child Safety Lock-Out

## REPLACING HAND-HELD REMOTE CONTROL ONLY

If your remote ever needs to be replaced you will not need to replace the receiver.

To program receiver with a new hand-held remote, insert a small pin or paper clip into hole on receiver face plate marked PRG. The receiver will beep 3 times to indicate it is ready to accept a new remote transmitter. Press the ON/OFF button on your remote and the receiver will beep 4 times to confirm it receives commands from the new remote.

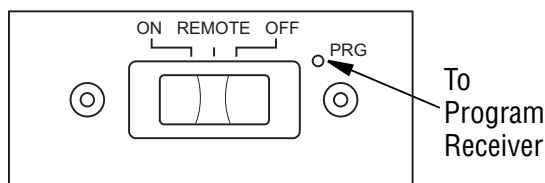


Figure 48 - Programming Remote Control to Receiver

## INSPECTING BURNERS

Check pilot flame pattern and burner flame patterns often.

### PILOT FLAME PATTERN

Figure 49 shows a correct pilot flame pattern. Figure 50 shows an incorrect pilot flame pattern. The incorrect pilot flame is not touching the thermocouple. This will cause the thermocouple to cool. When the thermocouple cools, the appliance will shut down.

If pilot flame pattern is incorrect, as shown in Figure 50

- turn appliance off (see [To Turn Off Gas to Appliance](#), Page 27)

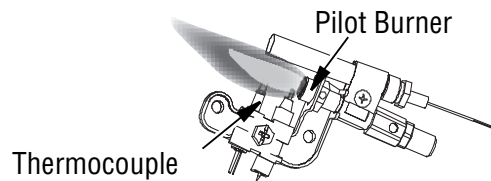


Figure 49 - Correct Pilot Flame Pattern

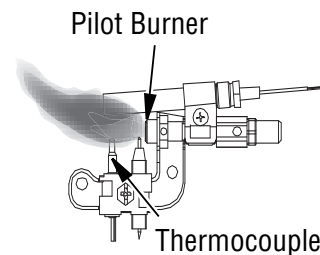


Figure 50 - Incorrect Pilot Flame Pattern

- see [Troubleshooting](#), Page 32

**NOTE:** The pilot flame on natural gas units will have a slight curve, but flame should be blue and have no yellow or orange color.

## CLEANING AND MAINTENANCE

**⚠ WARNING: Turn off appliance and let cool before cleaning.**

**⚠ CAUTION: You must keep control areas, burner and circulating air passageways of heater clean. Inspect these areas of heater before each use. Have heater inspected yearly by a qualified service person. Heater may need more frequent cleaning due to excessive lint from carpeting, bedding material, pet hair, etc.**

**⚠ WARNING: Failure to keep the primary air opening(s) of the burner(s) clean may result in sooting and property damage.**

**Perform a periodic visual check of pilot and burner flame.**

### BURNER INJECTOR HOLDER AND PILOT AIR INLET HOLE

The primary air inlet holes allow the proper amount of air to mix with the gas. This provides a clean burning flame. Keep these holes clear of dust, dirt, lint and pet hair. Clean these air inlet holes prior to each heating season. Blocked air holes will create soot. We recommend that you clean the unit every three months during operation and have appliance inspected yearly by a qualified service person.

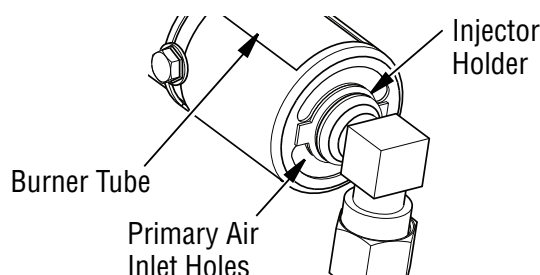
We also recommend that you keep the burner tube and pilot assembly clean and free of dust and dirt. To clean these parts we recommend using compressed air no greater than 30 PSI. Your local computer store, hardware store or home center may carry compressed air in a can. If using compressed air in a can, please follow the directions on the can. If you don't follow directions on the can, you could damage the pilot assembly.

1. Shut off unit, including pilot. Allow unit to cool for at least thirty minutes.
2. Inspect burner, pilot and primary air inlet holes on injector holder for dust and dirt (see **Figure 51**).
3. Blow air through the ports/slots and holes in the burner.
4. Check injector holder located at end of burner tube again. Remove any large particles of dust, dirt, lint or pet hair with a soft cloth or vacuum cleaner nozzle.

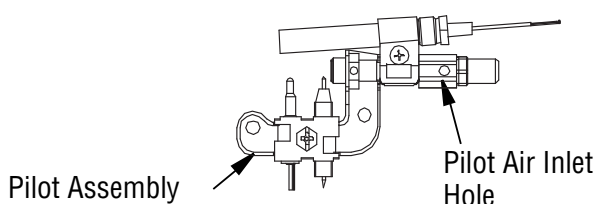
5. Blow air into the primary air holes on the injector holder.

6. In case any large clumps of dust have now been pushed into the burner repeat steps 3 and 4.

Clean pilot assembly also. Additional cleaning may be needed for proper pilot operation based on use/lack of use. A yellow tip on the pilot flame may indicate dust and dirt in the pilot assembly. There is a small pilot air inlet hole about from where the pilot flame comes out of pilot assembly (see **Figure 52**). With unit off, lightly blow air through air inlet hole. You may blow through a drinking straw if compressed air is not available.



**Figure 51 - Injector Holder On Outlet Burner Tube**



**Figure 52 - Pilot Inlet Air Hole (Your pilot may vary from pilot shown)**

### LOGS

- If you remove logs for cleaning, refer to *Installing Logs, Embers and Volcanic Stone*, **Page 18**, to properly replace logs.
- Replace log(s) if broken or chipped (dime-sized or larger).

### MAIN BURNER

Periodically inspect all burner flame holes with appliance running. All slotted burner flame holes should be open with flame present. All round burner flame holes should be open with a small blue flame present. Some burner flame holes may become blocked by debris or rust, with no flame present. If so, turn off appliance and let cool. Remove blockage, blocked burner flame holes will create soot.

**⚠ WARNING: The injector holders (air shutters) are not adjustable. Do not move injector holders from their original positions.**



## SPECIFICATIONS

**MAGNIFLAME24MN**  
**MAGNIFLAME24VN**  
**MAGNIFLAME30MN**  
**MAGNIFLAME30VN**

- Rating (Variable): 29,000/40,000 Btu/Hr
- Type Gas: Natural
- Ignition: Electronic
- Manifold Pressure: 3.4" W.C.
- Inlet Gas Pressure (in. of water):  
 Max - 10.5" W.C., Min\* - 5" W.C.

\*For purpose of input adjustment

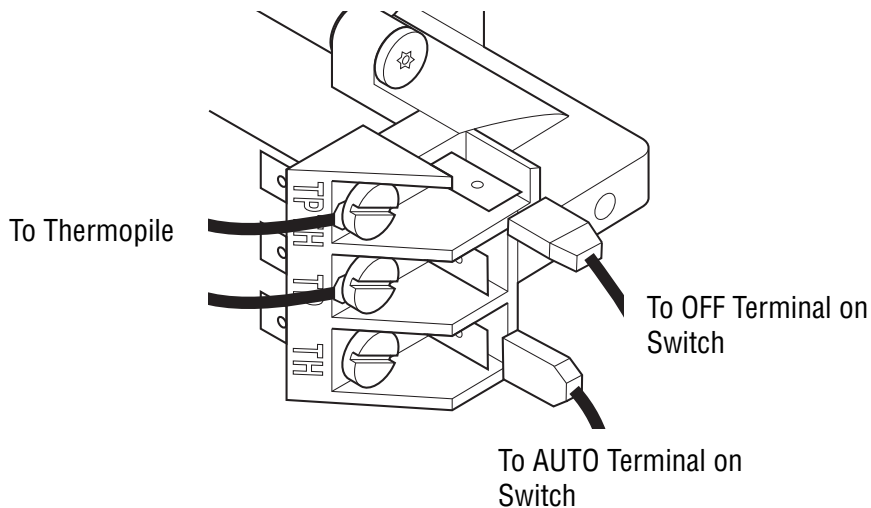
**MAGNIFLAME24MP**  
**MAGNIFLAME24VP**  
**MAGNIFLAME30MP**  
**MAGNIFLAME30VP**

- Rating (Variable): 29,000/40,000 Btu/Hr
- Type Gas: Propane/LP
- Ignition: Electronic
- Manifold Pressure: 7.9" W.C.
- Inlet Gas Pressure (in. of water):  
 Max - 14" W.C., Min\* - 11" W.C.

\*For purpose of input adjustment

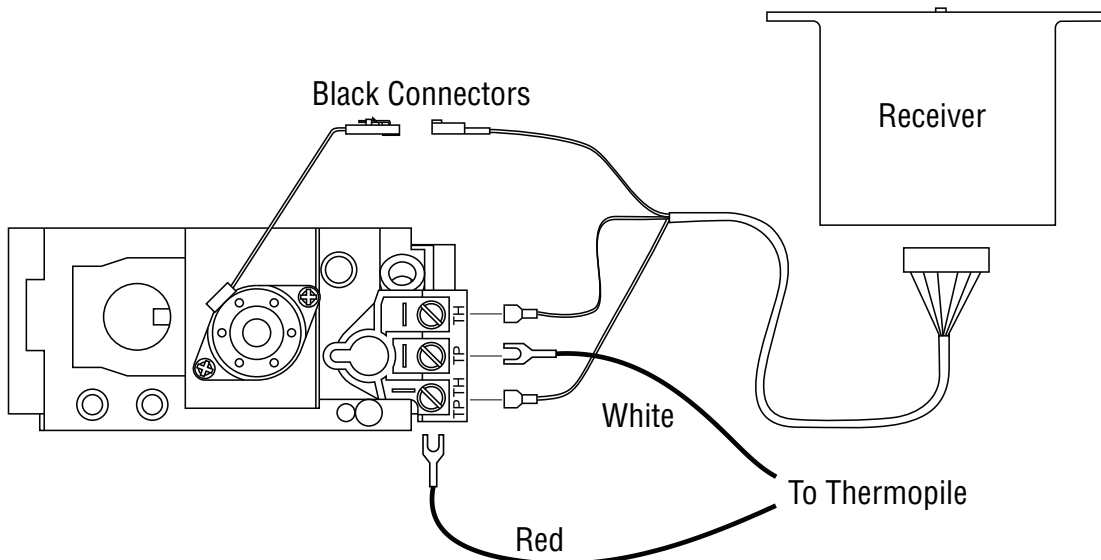
**⚠ CAUTION: Label all wires prior to disconnection when servicing controls. Wiring errors can cause improper and dangerous operation. Verify proper operation after servicing.**

### WIRING DIAGRAM (REMOTE READY MODELS)



### WIRING DIAGRAM (VARIABLE CONTROL MODELS)

**NOTE:** For proper operation of remote control, wires from thermopile to control receiver must be connected exactly as shown.



## TROUBLESHOOTING

**⚠ WARNING:** Turn off appliance and let cool before servicing. Only a qualified service person should service and repair heater.

**⚠ CAUTION:** Never use a wire, needle or similar object to clean ODS/pilot. This can damage ODS/pilot unit.

*NOTE: All troubleshooting items are listed in order of operation.*

OBSERVED PROBLEM	POSSIBLE CAUSE	REMEDY
Embers won't stay on burner	1. Ember placement	1. Overlap ember material 1/4" (see <b>Page 22</b> )
When Igniter button is pressed, there is no spark at ODS/pilot	1. Igniter electrode not connected to Igniter cable 2. Igniter cable pinched or wet  3. Broken Igniter cable 4. Bad Igniter 5. Igniter electrode positioned wrong 6. Igniter electrode broken 7. Battery not installed, battery power low or battery not installed correctly (electronic ignition models only)	1. Reconnect Igniter cable 2. Free Igniter cable if pinched by any metal or tubing. Keep Igniter cable dry 3. Replace Igniter cable 4. Replace Igniter 5. Replace pilot assembly 6. Replace pilot assembly 7. Install new alkaline battery in electronic Igniter. Verify battery is installed correctly
When Igniter button is pressed, there is spark at ODS/pilot but no ignition	1. Gas supply turned off or equipment shutoff valve closed 2. Control knob not in PILOT position 3. Control knob not pressed in while in PILOT position 4. Air in gas lines when installed  5. Depleted gas supply (propane/LP only) 6. ODS/pilot is clogged  7. Gas regulator setting is not correct	1. Turn on gas supply or open equipment shutoff valve 2. Turn control knob to PILOT position 3. Press in control knob while in PILOT position 4. Continue holding down control knob. Repeat igniting operation until air is removed 5. Contact local propane/LP gas company 6. Clean ODS/pilot (see <i>Cleaning and Maintenance, Page 30</i> ) or replace ODS/pilot assembly 7. Replace gas regulator



## TROUBLESHOOTING

### *Continued*

OBSERVED PROBLEM	POSSIBLE CAUSE	REMEDY
ODS/pilot lights but flame goes out when control knob is released	<ol style="list-style-type: none"> <li>1. Control knob not fully pressed in</li> <li>2. Control knob not pressed in long enough</li> <li>3. Safety interlock system has been triggered</li> <li>4. Equipment shutoff valve not fully open</li> <li>5. Pilot flame not touching thermocouple, which allows thermocouple to cool, causing pilot flame to go out. This problem could be caused by one or both of the following:                             <ol style="list-style-type: none"> <li>A) Low gas pressure</li> <li>B) Dirty or partially clogged ODS/pilot</li> </ol> </li> <li>6. Thermocouple connection loose at control valve</li> <li>7. Thermocouple damaged</li> <li>8. Control valve damaged</li> </ol>	<ol style="list-style-type: none"> <li>1. Press in control knob fully</li> <li>2. After ODS/pilot lights, keep control knob pressed in 30 seconds</li> <li>3. Wait one minute for safety interlock system to reset. Repeat ignition operation</li> <li>4. Fully open equipment shutoff valve</li> <li>5. A) Contact local natural or propane/LP gas company  B) Clean ODS/pilot (see <i>Cleaning and Maintenance, Page 30</i>) or replace ODS/pilot assembly</li> <li>6. Hand tighten until snug, then tighten 1/4 turn more</li> <li>7. Replace pilot assembly</li> <li>8. Replace control valve</li> </ol>
One or both burners do not light after ODS/pilot is lit	<ol style="list-style-type: none"> <li>1. Inlet gas pressure is too low</li> <li>2. Burner orifice(s) clogged</li> <li>3. Thermopile leads disconnected or improperly connected.</li> <li>4. Remote selector in OFF position</li> <li>5. Wire disconnected from gas control</li> </ol>	<ol style="list-style-type: none"> <li>1. Contact local natural or propane/LP gas company</li> <li>2. Clean burner(s) (see <i>Cleaning and Maintenance, Page 30</i>) or replace burner orifice(s)</li> <li>3. Reconnect leads see <i>Wiring Diagram, Page 31</i></li> <li>4. Put remote selector in ON position</li> <li>5. See <i>Wiring Diagram, Page 31</i></li> </ol>
Delayed ignition of one or both burners	<ol style="list-style-type: none"> <li>1. Manifold pressure is too low</li> <li>2. Burner orifice(s) clogged</li> <li>3. Mislocated crossover tube</li> </ol>	<ol style="list-style-type: none"> <li>1. Contact local natural or propane/LP gas company</li> <li>2. Clean burner(s) (see <i>Cleaning and Maintenance, Page 30</i>) or replace burner orifice(s)</li> <li>3. Contact qualified service person</li> </ol>
Burner backfiring during combustion	<ol style="list-style-type: none"> <li>1. Burner orifice is clogged or damaged</li> <li>2. Damaged burner</li> <li>3. Gas regulator defective</li> </ol>	<ol style="list-style-type: none"> <li>1. Clean burner (see <i>Cleaning and Maintenance, Page 30</i>) or replace burner orifice</li> <li>2. Replace damaged burner</li> <li>3. Replace gas regulator</li> </ol>

## TROUBLESHOOTING

*Continued*

OBSERVED PROBLEM	POSSIBLE CAUSE	REMEDY
Yellow flame in front burner during burner combustion	<ol style="list-style-type: none"> <li>1. Not enough air</li> <li>2. Gas regulator defective</li> </ol>	<ol style="list-style-type: none"> <li>1. Check burner(s) for dirt and debris. If found, clean burner(s) (see <i>Cleaning and Maintenance, Page 30</i>)</li> <li>2. Replace gas regulator</li> </ol>
Slight smoke or odor during initial operation	<ol style="list-style-type: none"> <li>1. Residues from manufacturing processes and logs curing</li> </ol>	<ol style="list-style-type: none"> <li>1. Problem will stop after a few hours of operation</li> </ol>
Appliance produces a whistling noise when burners are lit	<ol style="list-style-type: none"> <li>1. Turning control knob to HI position when burners are cold</li> <li>2. Air in gas line</li> <li>3. Air passageways on appliance blocked</li> <li>4. Dirty or partially clogged burner orifice(s)</li> </ol>	<ol style="list-style-type: none"> <li>1. Turn control knob to LO position and let warm up for a minute</li> <li>2. Operate burners until air is removed from line. Have gas line checked by local natural or propane/LP gas company</li> <li>3. Observe minimum installation clearances (see <i>Pages 9-11</i>)</li> <li>4. Clean burners (see <i>Cleaning and Maintenance, Page 30</i>) or replace burner orifice(s)</li> </ol>
White powder residue forming within burner box or on adjacent walls or furniture	<ol style="list-style-type: none"> <li>1. When heated, vapors from furniture polish, wax, carpet cleaners, etc. may turn into white powder residue</li> </ol>	<ol style="list-style-type: none"> <li>1. Turn appliance off when using furniture polish, wax, carpet cleaners or similar products</li> </ol>
Moisture/condensation noticed on windows	<ol style="list-style-type: none"> <li>1. Not enough combustion/ventilation air</li> </ol>	<ol style="list-style-type: none"> <li>1. Refer to <i>Air for Combustion and Ventilation</i> requirements (<i>Page 6</i>)</li> </ol>
Remote does not function	<ol style="list-style-type: none"> <li>1. Battery is not installed. Battery power is low</li> </ol>	<ol style="list-style-type: none"> <li>1. Replace batteries in receiver and hand-held remote</li> </ol>
Appliance produces a clicking/ticking noise just after burners are lit or shut off	<ol style="list-style-type: none"> <li>1. Metal expanding while heating or contracting while cooling</li> <li>2. Wire connection loose or wire broken</li> </ol>	<ol style="list-style-type: none"> <li>1. This is normal with most appliances. If noise is excessive, contact qualified service person</li> <li>2. Check wiring connections (see <i>wiring diagram, Page 31</i>). Replace wire harness if necessary.</li> </ol>

## TROUBLESHOOTING

*Continued*

- ⚠ WARNING: If you smell gas**
- **Shut off gas supply.**
  - **Do not try to light any appliance.**
  - **Do not touch any electrical switch; do not use any phone in your building.**
  - **Immediately call your gas supplier from a neighbor's phone. Follow the gas supplier's instructions.**
  - **If you cannot reach your gas supplier, call the fire department.**

**IMPORTANT:** Operating heater where impurities in air exist may create odors. Cleaning supplies, paint, paint remover, cigarette smoke, cements and glues, new carpet or textiles, etc., create fumes. These fumes may mix with combustion air and create odors. These odors will disappear over time.

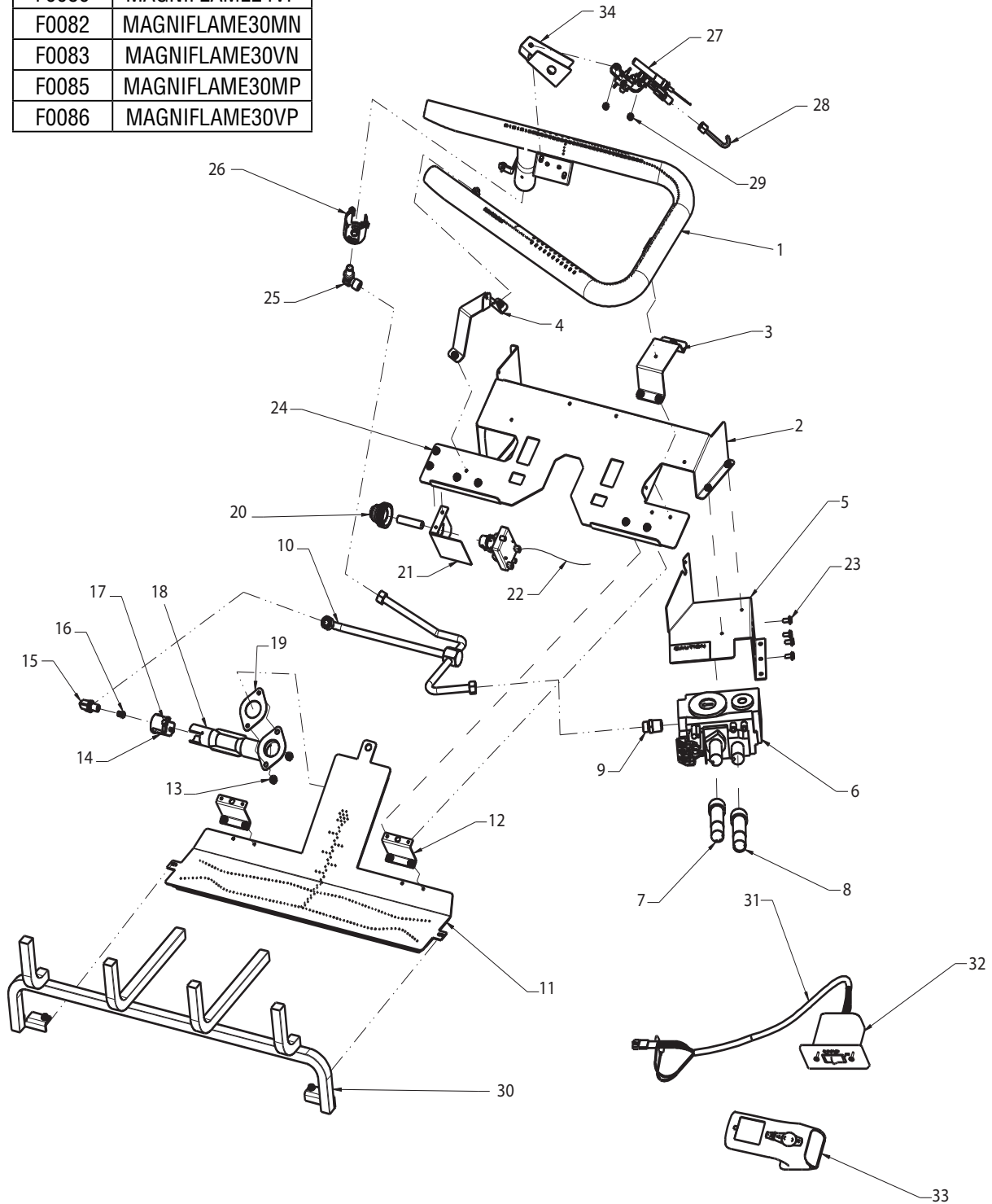
OBSERVED PROBLEM	POSSIBLE CAUSE	REMEDY
Appliance produces unwanted odors	<ol style="list-style-type: none"> <li>1. Appliance burning vapors from paint, hair spray, glues, cleaners, chemicals, new carpet, etc. (See <i>IMPORTANT</i> statement above)</li> <li>2. Low fuel supply (propane/LP only)</li> <li>3. Gas leak. <b>See Warning statement at top of Page</b></li> </ol>	<ol style="list-style-type: none"> <li>1. Open window to ventilate room. Stop using odor causing products while appliance is running</li> <li>2. Refill supply tank (propane/LP only)</li> <li>3. Locate and correct all leaks (see <i>Checking Gas Connections, Page 15</i>)</li> </ol>
Appliance shuts off in use (ODS operates)	<ol style="list-style-type: none"> <li>1. Not enough fresh air is available</li> <li>2. Low line pressure</li> <li>3. ODS/pilot is partially clogged</li> </ol>	<ol style="list-style-type: none"> <li>1. Open window and/or door for ventilation</li> <li>2. Contact local natural or propane/LP gas company</li> <li>3. Clean ODS/pilot (see <i>Cleaning and Maintenance, Page 30</i>)</li> </ol>
Gas odor even when control knob is in OFF position	<ol style="list-style-type: none"> <li>1. Gas leak. <b>See Warning statement at top of Page</b></li> <li>2. Control valve or gas control defective</li> </ol>	<ol style="list-style-type: none"> <li>1. Locate and correct all leaks (see <i>Checking Gas Connections, Page 15</i>)</li> <li>2. Replace control valve or gas control</li> </ol>
Gas odor during combustion	<ol style="list-style-type: none"> <li>1. Foreign matter between control valve and burner</li> <li>2. Gas leak. <b>See Warning statement at top of Page</b></li> </ol>	<ol style="list-style-type: none"> <li>1. Take apart gas tubing and remove foreign matter</li> <li>2. Locate and correct all leaks (see <i>Checking Gas Connections, Page 15</i>)</li> </ol>
Log set cycles to pilot, but room temperature drops to a lower than ideal level before log set comes back on	<ol style="list-style-type: none"> <li>1. Hand-held remote control is too close to appliance</li> </ol>	<ol style="list-style-type: none"> <li>1. Move hand-held remote control unit farther away from the appliance</li> </ol>

# PARTS

## REMOTE-READY VARIABLE CONTROL MODELS

MAGNIFLAME24MN, MAGNIFLAME24VN, MAGNIFLAME24MP, MAGNIFLAME24VP, MAGNIFLAME30MN, MAGNIFLAME30VN, MAGNIFLAME30MP AND MAGNIFLAME30VP

Cat. No.	Model
F0076	MAGNIFLAME24MN
F0077	MAGNIFLAME24VN
F0079	MAGNIFLAME24MP
F0080	MAGNIFLAME24VP
F0082	MAGNIFLAME30MN
F0083	MAGNIFLAME30VN
F0085	MAGNIFLAME30MP
F0086	MAGNIFLAME30VP



**⚠ WARNING: Failure to position the parts in accordance with these diagrams or failure to use only parts specifically approved with this heater may result in property damage or personal injury.**

## PARTS

### REMOTE-READY VARIABLE CONTROL MODELS

**MAGNIFLAME24MN, MAGNIFLAME24VN, MAGNIFLAME24MP, MAGNIFLAME24VP, MAGNIFLAME30MN, MAGNIFLAME30VN, MAGNIFLAME30MP AND MAGNIFLAME30VP**

This list contains replaceable parts used in your appliance. When ordering parts, follow the instructions listed under Replacement Parts on **Page 40** of this manual.

**⚠ WARNING: Contact an IHP dealer to obtain any of these parts. Never use substitute materials not approved by IHP. Use of non-approved parts can result in poor performance and safety hazards.**

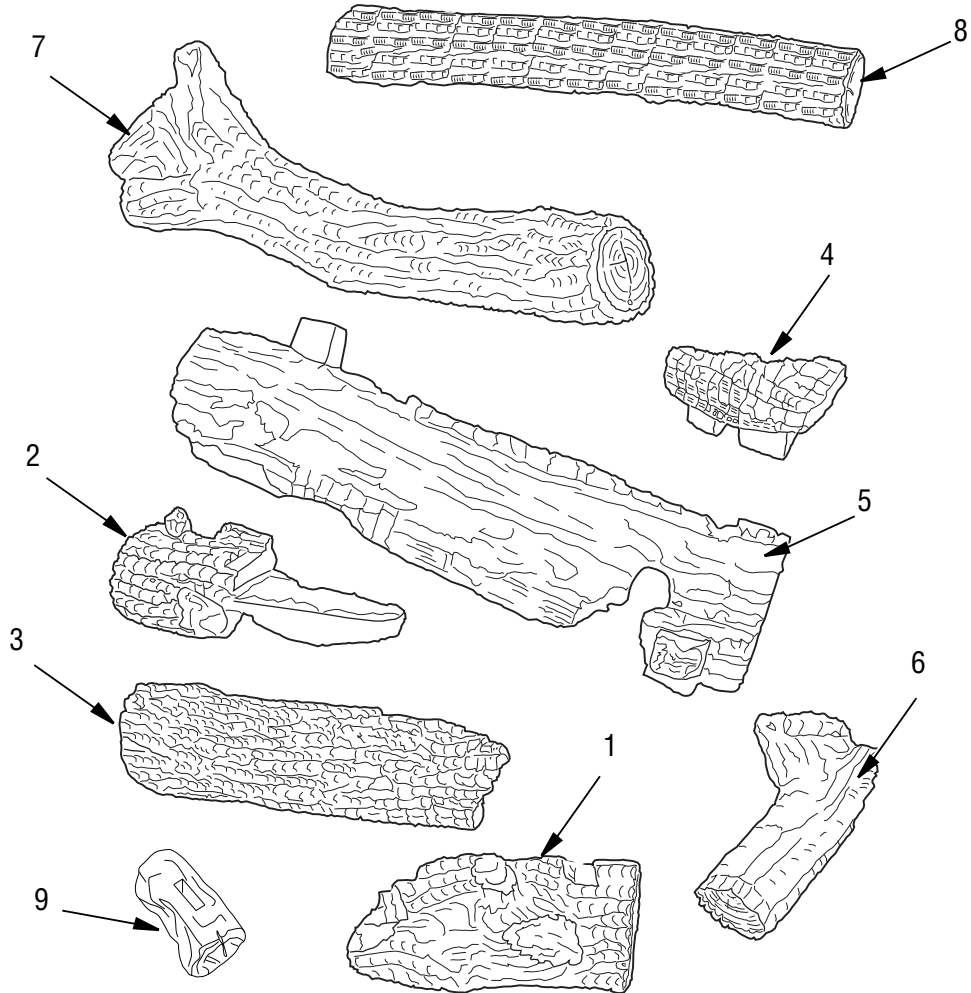
KEY NO.	CAT. NO.	DESCRIPTION	MNF24NM	MNF24PM	MNF30NM	MNF30PM	MNF24NV	MNF24PV	MNF30NV	MNF30PV	QTY.
1	J6356	Burner MF Dual Yellow Flame	•	•	•	•	•	•	•	•	1
2	J8094	Base	•	•	•	•	•	•	•	•	1
3	J8175	Bracket Right Burner	•	•	•	•	•	•	•	•	1
4	J8176	Bracket Left Burner	•	•	•	•	•	•	•	•	1
5	J8086	Bracket Remote Valve	•	•	•	•	•	•	•	•	1
6	J3836	Gas Valve, NG	•	•	•						1
	J3837	Gas Valve, LP		•	•						1
	K2005	Valve, Remote (w/Stepper Mt.) NG				•		•			1
	K2005	Valve, Remote (w/Stepper Mt.) LP					•		•		1
7	J3840	Knob Short Extension (Pilot)	•	•	•	•	•	•	•	•	1
8	J3841	Knob Short Extension (HI-LO)	•	•	•	•					1
9	J3562	Male Connector	•	•	•	•	•	•	•	•	1
10	J7716	Tube Inlet	•	•	•	•	•	•	•	•	1
11	J6364	Asm Pan Burner	•	•	•	•	•	•	•	•	1
12	J6147	Bracket Front Burner	•	•	•	•	•	•	•	•	2
13	J3547	Nut Captive Washer	•	•	•	•	•	•	•	•	2
14	J4886	Air Shutter	•	•	•	•	•	•	•	•	1
15	J6127	Orifice Holder 90 Degree	•	•	•	•	•	•	•	•	1
16	J8098	Orifice, 0.052 (1.321 mm)	•	•	•	•	•	•	•	•	1
	J8169	Orifice, .028 (Pan)		•	•		•		•	•	1
17	J1958	Screw, HWH AB 8-18 X .38	•	•	•	•	•	•	•	•	4
18	J5416	Venturi Tube	•	•	•	•	•	•	•	•	1
19	J5456	Burner Gasket	•	•	•	•	•	•	•	•	1
20	J4596	Igniter, Electronic	•	•	•	•	•	•	•	•	1
21	J6144	Bracket Igniter	•	•	•	•	•	•	•	•	1
22	J3571	Cable Igniter	•	•	•	•	•	•	•	•	1
23	J1961	Screw HX SLT WSR 10-32 x 3/8	•	•	•	•	•	•	•	•	4
24	J1955	Screw HWH AB 10-16 X .38	•	•	•	•	•	•	•	•	22
25	J4720	Orifice Elbow P53 95 420 (Rear)		•	•		•		•	•	1
	J4721	Orifice Elbow P52 85 1000 (Rear)	•		•			•		•	1
26	J5199	Air Shutter		•	•		•		•	•	1
	J5200	Air Shutter	•		•		•		•	•	1
27	J6424	Pilot ODS LP Copreci # 231		•	•		•		•	•	1
	J6425	Pilot ODS NG Copreci # 240	•		•		•		•	•	1
28	J3635	Tube Pilot	•	•	•	•	•	•	•	•	1
29	J3558	Nut ODS	•	•	•	•	•	•	•	•	2
30	J6491	Grate MF42	•	•			•	•			1
	J6491	Grate MF48			•	•			•	•	1
31	J5680	Wire Harness, Proflame					•	•	•	•	1
32	J5681	Proflame Receiver Kit					•	•	•	•	1
33	J5678	Remote, Proflame					•	•	•	•	1
34	J6508	Bracket Pilot MF42		•	•			•		•	1

## PARTS

### LOG SET MODELS

#### SOUTHERNCOMFORT24A/B, SOUTHERNCOMFORT30A/B, SOUTHERNCOMFORT36A/B

This list contains replaceable parts used in your appliance. When ordering parts, follow the instructions listed under [Replacement Parts](#) on **Page 40** of this manual.



KEY NO.	SOUTHERNCOMFORT24A/B		SOUTHERNCOMFORT30A/B		SOUTHERNCOMFORT36A/B		DESCRIPTION	QTY.
	CAT. NO.	Log Id. #	CAT. NO.	Log Id. #	CAT. NO.	Log Id. #		
1	J6696	D-061	J6516	D-019	J6527	D-027	Log, Front Right	1
2	J6697	D-060	J6517	D-018	J6528	D-026	Log, Back Left	1
3	J6698	D-059	J6518	D-017	J6529	D-025	Log, Front Left	1
4	J6519	D-020	J6519	D-020	J6519	D-020	Log, Charred	1
5	J6699	D-063	J6520	D-021	J6530	D-028	Log, Middle Split	1
6	J6521	D-022	J6521	D-022	J6521	D-022	Log, Right Split Crossover	1
7	J6522	D-024	J6522	D-024	J6522	D-024	Log, Front Top	1
8	J6700	D-062	J6523	D-023	J6531	D-029	Log, Back Top	1
9	J6496	None	J6496	None	J6496	None	Log Switch	1

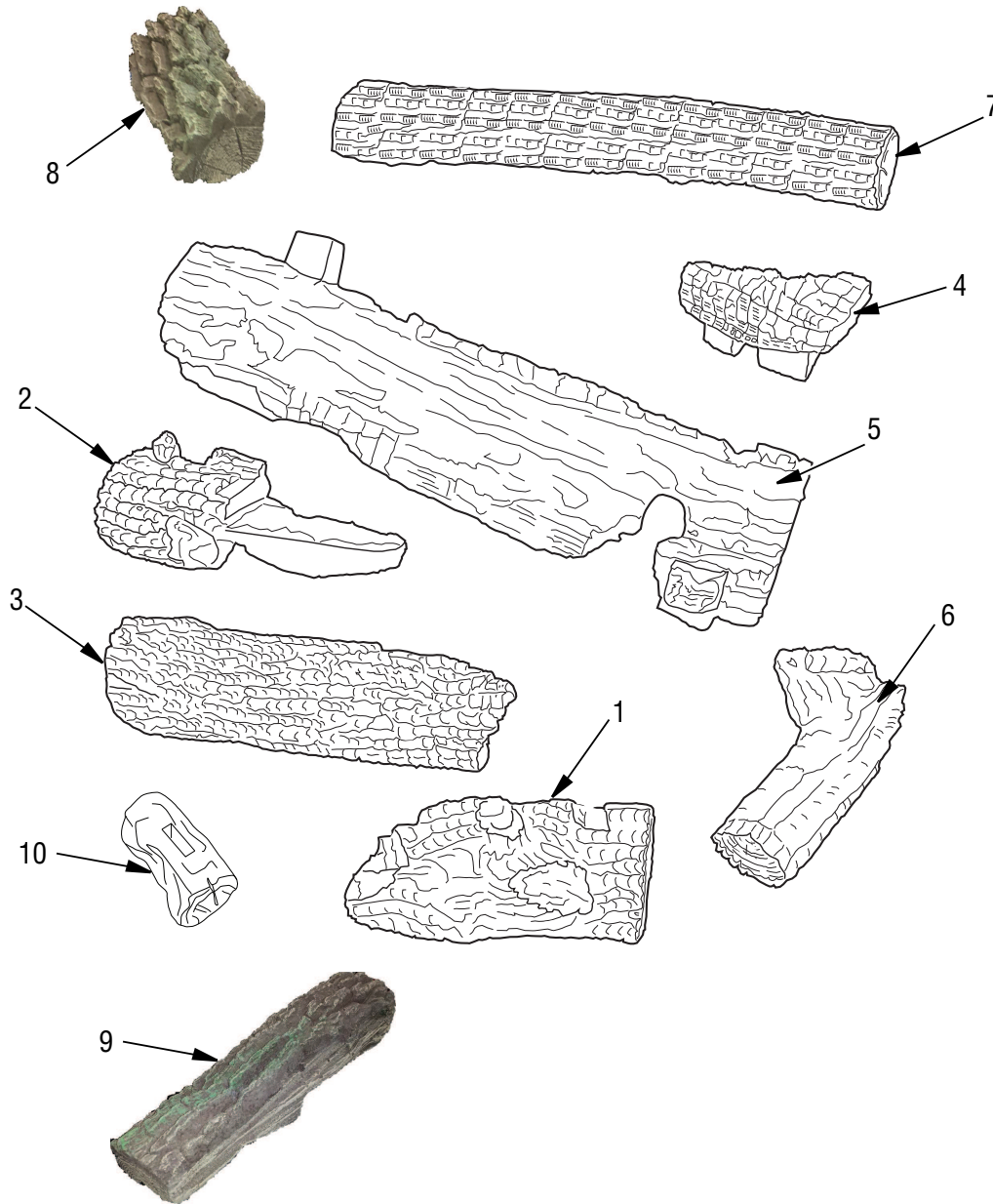
Each log includes a reference number. The first number indicates the order it is placed on the burner assembly. The next two numbers indicate the set size.

## PARTS

### LOG SET MODELS

#### SHADYHOLLOW24A/B, SHADYHOLLOW30A/B AND SHADYHOLLOW36A/B

This list contains replaceable parts used in your appliance. When ordering parts, follow the instructions listed under Replacement Parts on **Page 40** of this manual.



KEY NO.	SHADYHOLLOW24A/B		SHADYHOLLOW30A/B		SHADYHOLLOW36A/B		DESCRIPTION	QTY.
	CAT. NO.	Log Id. #	CAT. NO.	Log Id. #	CAT. NO.	Log Id. #		
1	J8245	D-061	J8253	D-019	J8259	D-027	Log, Front Right	1
2	J8246	D-060	J8254	D-018	J8260	D-026	Log, Back Left	1
3	J8247	D-059	J8255	D-017	J8261	D-025	Log, Front Left	1
4	J6519	D-020	J6519	D-020	J6519	D-020	Log, Charred	1
5	J8248	D-063	J8256	D-021	J8256	D-028	Log, Middle Split	1
6	J8249	D-022	J8257	D-022	J8263	D-022	Log, Right Split Crossover	1
7	J8249	D-062	J8258	D-023	J8264	D-029	Log, Back Top	1
8	J8251	D-080	J8251	D-080	J8251	D-080	Log, Top Left	1
9	J8252	D-081	J8252	D-081	J8252	D-081	Log, Top Right	1
10	F2676	None	F2676	None	F2676	None	Log Switch	1

Each log includes a reference number. The first number indicates the order it is placed on the burner assembly. The next two numbers indicate the set size.

## PARTS

This list contains replaceable parts used in your appliance. When ordering parts, follow the instructions listed under *Replacement Parts* below.

### PARTS AVAILABLE, NOT SHOWN - ALL MODELS

J3658	Warning Plate	1
J3846	Lighting Instruction Plate	1
J3664	Caution Decal	1
J3689	Hardware Kit	1
80L42	Volcanic Stone	1
J8174	Flextube with Fitting	1
J6208	Glowing Embers	1
J6207	Platinum Bright Embers Kit	1
J3656	Fan Switch	1
J3800	Wire Harness	1
J3799	Wire Harness	1

## REPLACEMENT PARTS

See **Pages 36-40** for a complete replacement parts list. Use only parts supplied from the manufacturer.

Normally, all parts should be ordered through your IHP distributor or dealer. Parts will be shipped at prevailing prices at time of order.

When ordering repair parts, always give the following information:

1. The model number of the appliance.
2. The serial number of the appliance.
3. The part number.
4. The description of the part.
5. The quantity required.
6. The installation date of the appliance.

If you encounter any problems or have any questions concerning the installation or application of this appliance, please contact your dealer.

## SERVICE HINTS

### When Gas Pressure Is Too Low

- pilot will not stay lit
- burners will have delayed ignition
- appliance will not produce specified heat
- propane/LP gas supply may be low

You may feel your gas pressure is too low. If so, contact your local propane/LP or natural gas supplier.

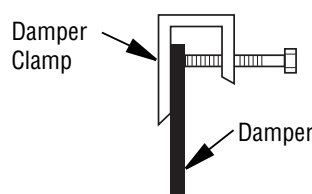
## TECHNICAL SERVICE

You may have further questions about installation, operation, or troubleshooting. Please contact your IHP dealer for any questions or concerns. When contacting your dealer please have your model and serial numbers of your appliance ready. You can also visit our web site at [Astria.us.com](http://Astria.us.com).

## ACCESSORIES

Purchase these appliance accessories from your local dealer. If they can not supply these accessories, contact IHP at [Astria.us.com](http://Astria.us.com) for referral information. You can also write to the address listed on the back Page of this manual.

**Only kits supplied by IHP shall be used in the installation of this appliance. Use of non-approved accessory/part kit(s) can result in poor performance and safety hazards.**



### DAMPER CLAMP

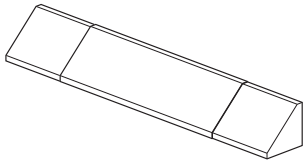
**Cat No. F1760, Model GA6080**

**For all models.** Permanently opens chimney flue damper for vented operation.



## ACCESSORIES

*Continued*



### FIREPLACE HOOD, BLACK

**Cat No. F1764, Model GA6050**

**For all models.** Helps deflect heat away from mantel or wall above fireplace. Fits openings 28" to 48" wide.

### VOLCANIC STONE

**Cat No. 80L42, Model FDVS**

**For all models.** Order when additional volcanic stone is desired.

### EMBER KITS

**Platimun Embers**

**Cat. No J6207**

**Glowing Embers (rockwool)**

**Cat. No J6208**



### FLOOR MEDIA KIT

**Cat No. F1762, Model FM100**

**For all models.** Includes volcanic stone, burner embers, and burner cinders.



### LOG ACCESSORY KIT

**Cat No. F0252, Model LAMF**

**For all models.** These decorative hearth area log scraps/control cover kit is for used with IHP gas log sets.



### LOG SCRAPS - FLOOR MEDIA KIT - 1

**Cat. No. F0250, Model VTA-LS5-1**



### LOG SCRAPS - FLOOR MEDIA KIT - 2

**Cat. No. F0251, Model VTA-LS5-2**



### DECORATIVE ASH BED / CONTROL COVER KIT (SIX PACK)

**Cat. No. F1759, Model CDABKA-6**

### DECORATIVE ASH BED / CONTROL COVER KIT

**Cat. No. F0246, Model CDABKA**

## ACCESSORIES

*Continued*

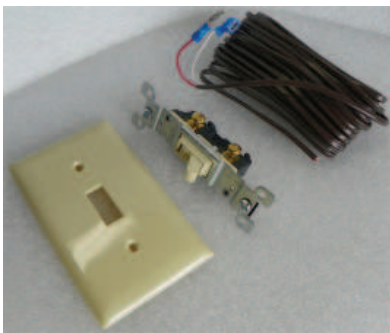


**GAS APPLIANCE INSTALLATION KIT**  
Cat. No. F0249, Model CIKA



**WALL-MOUNT THERMOSTAT SWITCH**  
Cat No. F2040, Model GWMT1  
**(REMOTE READY MODELS ONLY)**

**For all models.** The desired comfort setting can be selected on the wall thermostat and the log appliance will automatically cycle from pilot to the heat setting selected.



**WALL-MOUNT ON/OFF SWITCH - Cat No. F0245, Model GWMS2**  
**(REMOTE READY MODELS ONLY)**

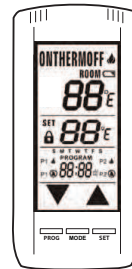
**For all models.** Allows the gas log appliance to be turned on and off with a wall switch.



**ON/OFF REMOTE AND RECEIVER WITH WHITE WALL PLATE**

**Cat. No. F2236, Model RCKIT4001**

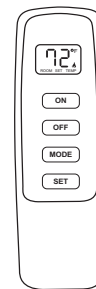
**For all Remote-Ready Models.** Allows the fireplace to be turned on and off by using a hand-held remote control.



**RECEIVER AND REMOTE CONTROL KIT**

**Cat. No. F1079, Model TSRC**

**For all Remote-Ready Models.** Allows the burner system to be operated in a manually or thermostatically controlled mode. Remote is programmable for your convenience and has a large bright LCD Touch Screen for easy use.



**RECEIVER AND THERMOSTAT REMOTE CONTROL KIT**

**Cat No. F1078, Model TRC**

**(REMOTE READY MODELS ONLY)**

**For all remote-ready models.** Allows the fireplace to be operated in a manually or thermostatically controlled mode. You can turn the fireplace on and off without ever leaving the comfort of your easy chair.

# Innovative Hearth Products Astria® Brand Gas Log Set & Outdoor Gas Fire Pit Limited Three Year Warranty

## THE WARRANTY

Innovative Hearth Products Limited Three Year Warranty ("IHP") warrants your Astria® brand Gas Log Set or Outdoor Gas Fire Pit ("Product") to be free from defects in materials and workmanship at the time of manufacture. The logs and grate carry the Limited Three Year Warranty. After installation, if covered components manufactured by IHP are found to be defective in materials or workmanship during the Limited Three Year Warranty period and while the Product remains at the site of the original installation, IHP will, at its option, repair or replace the covered components. If repair or replacement is not commercially practical, IHP will, at its option, refund the purchase price or wholesale price of the IHP product, whichever is applicable. IHP will also pay IHP prevailing labor rates, as determined in its sole discretion, incurred in repairing or replacing such components. THERE ARE EXCLUSIONS AND LIMITATIONS to this Limited Three Year Warranty as described herein.

## COVERAGE COMMENCEMENT DATE

Warranty coverage begins on the date of purchase. In the case of new home construction, warranty coverage begins on the date of first occupancy of the dwelling or six months after the sale of the Product by an independent IHP dealer, whichever occurs earlier. The warranty shall commence no later than 24 months following the date of product shipment from IHP, regardless of the installation or occupancy date.

## EXCLUSIONS AND LIMITATIONS

This Limited Three Year Warranty applies only if the Product is installed in the United States or Canada and only if operated and maintained in accordance with the printed instructions accompanying the Product and in compliance with all applicable installation and building codes and good trade practices.

This warranty is non-transferable and extends to the original owner only. The Product must be purchased through a listed supplier of IHP and proof of purchase must be provided. The following do not carry the Limited Three Year Warranty but are warranted as follows:

- Gas components** – Repair or replacement for one year from the date of installation.
- Remote control** – Repair or replacement for one year from the date of installation.
- Labor coverage** – Prevailing IHP labor rates apply for the warranty period of the component.

**Parts not otherwise listed carry a 90 day warranty from the date of installation.**

**Whenever practicable, IHP will provide replacement parts, if available, for a period of 10 years from the last date of manufacture of the product.**

IHP will not be responsible for: (a) damages caused by normal wear and tear, accident, riot, fire, flood or acts of God; (b) damages caused by abuse, negligence, misuse, or unauthorized alteration or repair of the Product affecting its stability or performance (The Product must be subjected to normal use. The Product is designed to burn either natural or propane gas only. Burning conventional fuels such as wood, coal or any other solid fuel will cause damage to the Product, will produce excessive temperatures and could result in a fire hazard.); (c) damages caused by failing to provide proper maintenance and service in accordance with the instructions provided with the Product; (d) damages, repairs or inefficiency resulting from faulty installation or application of the Product.

This Limited Three Year Warranty covers only parts and labor as provided herein. In no case shall IHP be responsible for materials, components or construction which are not manufactured or supplied by IHP or for the labor necessary to install, repair or remove such materials, components or construction. Additional utility bills incurred due to any malfunction or defect in equipment are not covered by this warranty. All replacement or repair components will be shipped F.O.B. from the nearest stocking IHP factory.

## LIMITATION ON LIABILITY

It is expressly agreed and understood that IHP's sole obligation and the purchaser's exclusive remedy under this warranty, under any other warranty, expressed or implied, or in contract, tort or otherwise, shall be limited to replacement, repair, or refund, as specified herein.

In no event shall IHP be liable for any incidental or consequential damages caused by defects in the Product, whether such damage occurs or is discovered before or after replacement or repair, and whether such damage is caused by IHP's negligence. IHP has not made and does not make any representation or warranty of fitness for a particular use or purpose, and there is no implied condition of fitness for a particular use or purpose.

IHP makes no expressed warranties except as stated in this Limited Three Year Warranty. The duration of any implied warranty is limited to the duration of this expressed warranty.

No one is authorized to change this Limited Three Year Warranty or to create for IHP any other obligation or liability in connection with the Product. Some states and provinces do not allow the exclusion or limitation of incidental or consequential damages, so the above limitations or exclusions may not apply to you. The provisions of this Limited Three Year Warranty are in addition to and not a modification of or subtraction from any statutory warranties and other rights and remedies provided by law.

## INVESTIGATION OF CLAIMS AGAINST WARRANTY

IHP reserves the right to investigate any and all claims against this Limited Three Year Warranty and to decide, in its sole discretion, upon the method of settlement.

To receive the benefits and advantages described in this Limited Three Year Warranty, the appliance must be installed and repaired by a licensed contractor approved by IHP.

Contact IHP at the address provided herein to obtain a listing of approved dealers/distributors. **IHP shall in no event be responsible for any warranty work done by a contractor that is not approved without first obtaining IHP's prior written consent.**

## HOW TO REGISTER A CLAIM AGAINST WARRANTY

In order for any claim under this warranty to be valid, you must contact the IHP dealer/distributor from which you purchased the product. If you cannot locate the dealer/distributor, then you must notify IHP in writing. IHP must be notified of the claimed defect in writing within 90 days of the date of failure. Notices should be directed to the IHP Warranty Department at 1769 East Lawrence Street; Russellville, AL 35654 or visit our website at [WWW.ASTRIA.US.COM](http://WWW.ASTRIA.US.COM).

**Astria.us.com**

Record the following important information about your appliance:

Appliance model number	
Appliance serial number	
Date appliance was Installed	
Type of gas appliance uses	
Dealer name	

---

Innovative Hearth Products (IHP) reserves the right to make changes at any time, without notice, in design, materials, specifications, prices and also to discontinue colors, styles and products. Consult your local distributor for fireplace code information.

Printed in U.S.A. © 2015 Innovative Hearth Products  
P/N 126807-01 Rev. E 01/2019



1769 East Lawrence Street • Russellville, AL 35654