



P/N 126854-01 REV. L 11/2022



Report No. F09-129

## Installation and Operation Instructions

### Unvented (Vent-Free) Gas Log Heater

#### Models

EOS18MN	EOS18MP
---------	---------

#### For use with log sets

BlondeOak18	ChestnutH18	ChestnutHillHD18
BlondeOak24	ChestnutH24	ChestnutHillHD24

**INSTALLER:** Leave this manual with the appliance.

**CONSUMER:** Retain this manual for future reference.

This appliance may be installed in an aftermarket permanently located, manufactured (mobile) home, where not prohibited by local codes. This appliance is only for use with the type of gas indicated on the rating plate. This appliance is not convertible for use with other gases.

**WARNING:** This appliance is for installation only in a solid-fuel burning masonry or UL127 factory-built fireplace or in a listed ventless firebox enclosure. It is design-certified for these installations in accordance with ANSI Z21.11.2. Exception: DO NOT install this appliance in a factory-built fireplace that includes instructions stating it has not been tested or should not be used with unvented gas logs.

This is an unvented gas-fired heater. It uses air (oxygen) from the room in which it is installed. Provisions for adequate combustion and ventilation air must be provided. Refer to Air for Combustion and Ventilation section on *Page 6* of this manual.

**⚠ WARNING:** If the information in this manual is not followed exactly, a fire or explosion may result causing property damage, personal injury or loss of life.

- Do not store or use gasoline or other flammable vapors and liquids in the vicinity of this or any other appliance.
- **WHAT TO DO IF YOU SMELL GAS**
  - Do not try to light any appliance.
  - Do not touch any electrical switch; do not use any phone in your building.
  - Immediately call your gas supplier from a neighbor's phone. Follow the gas supplier's instructions.
  - If you cannot reach your gas supplier, call the fire department.
- Installation and service must be performed by a qualified installer, service agency or the gas supplier.

**Thank you for your purchase. We appreciate your business!**

Please carefully read and follow all instructions in this manual. **Pay special attention to all warnings and safety information.**

Following these safety, care, and operation instructions will help ensure many years of dependable and enjoyable service from your fireplace.

**Please read and understand these instructions before installing or operating.**



**NATIONAL FIREPLACE INSTITUTE**  
**CERTIFIED**  
www.nficertified.org

We recommend that our gas hearth products be installed and serviced by professionals who are certified in the U.S. by the National Fireplace Institute® (NFI) as NFI Gas Specialists.

## TABLE OF CONTENTS

Safety.....	2
Product Identification.....	5
Local Codes .....	5
Unpacking.....	5
Commonwealth of Massachusetts Requirements .....	5
Product Features.....	5
Air for Combustion and Ventilation .....	6
Installation .....	8
Operation .....	20
Inspecting Burners.....	22
Cleaning and Maintenance .....	22
Troubleshooting .....	24
Parts .....	27
Wiring Diagram.....	32
Specifications .....	32
Replacement Parts.....	32
Service Hints.....	32
Technical Service .....	32
Accessories.....	33
Optional Remote Control Accessories.....	34
Warranty .....	35

## SAFETY

**⚠ WARNING: FIRE, EXPLOSION, AND ASPHYXIATION HAZARD**

Improper adjustment, alteration, service, maintenance, or installation of this heater or its controls can cause death or serious injury.

Read and follow instructions and precautions in User's Information Manual provided with this heater.

**⚠ WARNING:** This appliance is for installation only in a solid-fuel burning masonry or UL127 factory-built fireplace or in a listed ventless firebox enclosure. It is design-certified for these installations in accordance with ANSI Z21.11.2. Exception: Do not install this appliance in a factory-built fireplace that includes instructions stating it has not been tested or should not be used with unvented gas logs.

**⚠ WARNING:** Vent-free products are prohibited for bedroom and bathroom installation in the Commonwealth of Massachusetts.

**⚠ WARNING:** This product can expose you to chemicals including Carbon Black, which is known to the State of California to cause cancer, and Carbon Monoxide, which is known to the State of California to cause birth defects or other reproductive harm. For more information go to [www.P65Warnings.ca.gov](http://www.P65Warnings.ca.gov)

**⚠ WARNING:** This is an unvented gas-fired heater. It uses air (oxygen) from the room in which it is installed. Provisions for adequate combustion and ventilation air must be provided. Refer to Air for Combustion and Ventilation section on *Page 6* of this manual.

This appliance may be installed in an aftermarket, \* permanently located, manufactured (mobile) home, where not prohibited by local codes.

This appliance is only for use with the type of gas indicated on the rating plate. This appliance is not convertible for use with other gases.

\* Aftermarket: Completion of sale, not for purpose of resale, from the manufacturer

**IMPORTANT:** Read this owner's manual carefully and completely before trying to assemble, operate or service this appliance. Improper use of this heater can cause serious injury or death from burns, fire, explosion, electrical shock and carbon monoxide poisoning.

Any safety screen, guard, or barrier removed for servicing an appliance must be replaced prior to operating the heater. The firescreen or guard designed for this unvented appliance must be installed prior to operation.

## SAFETY *Continued*

**⚠ DANGER: Carbon monoxide poisoning may lead to death!**

**Carbon Monoxide Poisoning:** Early signs of carbon monoxide poisoning resemble the flu, with headaches, dizziness or nausea. If you have these signs, the heater may not be working properly. **Get fresh air at once!** Have heater serviced. Some people are more affected by carbon monoxide than others. These include pregnant women, people with heart or lung disease or anemia, those under the influence of alcohol and those at high altitudes.

**Natural and Propane/LP Gas:** Natural and propane/LP gases are odorless. An odor-making agent is added to the gas. The odor helps you detect a gas leak. However, the odor added to the gas can fade. Gas may be present even though no odor exists.

Make certain you read and understand all warnings. Keep this manual for reference. It is your guide to safe and proper operation of this heater.

**⚠ WARNING: Any change to this heater or its controls can be dangerous.**

**⚠ WARNING: Do not use a blower insert, heat exchanger insert or other accessory not approved for use with this heater.**

**⚠ WARNING: Do not allow fans to blow directly into the fireplace. Avoid any drafts that alter burner flame patterns. Ceiling fans can create drafts that alter burner flame patterns. Altered burner patterns can cause sooting.**

**Due to high temperatures, the appliance should be located out of traffic and away from furniture and draperies.**

**Do not place clothing or other flammable material on or near the appliance. Never place any objects on the heater.**

**Children and adults should be alerted to the hazard of high surface temperature and should stay away to avoid burns or clothing ignition. Heater will remain hot for a time after shutdown. Allow surface to cool before touching.**

**⚠ WARNING: Do not place log scraps or volcanic stone on burner.**

**Heater base assembly becomes very hot when running heater.**

**⚠ WARNING: Young children should be carefully supervised when they are in the same room with the appliance. When using the hand-held remote accessory, keep selector switch in the OFF position to prevent children from turning on burners with remote.**

**You must operate this heater with a fireplace screen in place. Make sure fireplace screen is closed before running heater. The fireplace screen shall have openings for introduction of combustion air.**

**Keep the appliance area clear and free from combustible materials, gasoline and other flammable vapors and liquids.**

**Solid-fuels shall not be burned in a fireplace in which an unvented room heater is installed.**

**Installation and repair should be done by a qualified service person. The appliance should be inspected before use and at least annually by a professional service person. More frequent cleaning may be required due to excessive lint from carpeting, bedding material, etc. It is imperative that control compartments, burners, and circulating air passageways of the appliance be kept clean.**

## SAFETY *Continued*

**1. WARNING: This appliance is only for use with the type of gas indicated on the rating plate. This appliance is not convertible for use with other gases.**

2. Do not place propane/LP supply tank(s) inside any structure. Locate propane/LP supply tank(s) outdoors (propane/LP units only).
3. To prevent performance problems, the use of a propane/LP tank of less than 100 lbs. capacity is not recommended (propane/LP units only).
4. If you smell gas
  - shut off gas supply
  - do not try to light any appliance
  - do not touch any electrical switch; do not use any phone in your building
  - immediately call your gas supplier from a neighbor's phone. Follow the gas supplier's instructions
  - if you cannot reach your gas supplier, call the fire department
5. This heater shall not be installed in a bedroom or bathroom unless installed as a vented appliance (see [Installing Damper Clamp Accessory for Vented Operation](#), **Page 11**).
6. **WARNING: Before installing in a solid fuel-burning fireplace, the chimney flue and firebox must be cleaned of soot, creosote, ashes and loose paint by a qualified chimney cleaner. Creosote will ignite if highly heated. A dirty chimney flue may create and distribute soot within the house. Inspect chimney flue for damage. If damaged, repair flue and firebox before operating appliance.**
7. Do not burn solid-fuel in a fireplace in which an unvented appliance is installed.
8. If appliance has glass doors, never operate this appliance with glass doors closed. Any glass doors shall be fully opened when the appliance is in operation. If you operate appliance with doors closed, heat buildup inside fireplace will cause glass to burst. Make sure there are no obstructions across openings of fireplace.
9. This log heater is designed to be smokeless. If logs ever appear to smoke, turn off heater and call a qualified service person. **NOTE:** During initial operation, slight smoking could occur due to log curing and heater burning manufacturing residues.
10. To prevent the creation of soot, follow the instructions in [Cleaning and Maintenance](#), **Page 22**.
11. Before using furniture polish, wax, carpet cleaner or similar products, turn appliance off. If heated, the vapors from these products may create a white powder residue within burner box or on adjacent walls and furniture.
12. This appliance needs fresh, outside air ventilation to run properly. This appliance has an Oxygen Depletion Sensing (ODS) safety shutoff system. The ODS shuts down the appliance if enough fresh air is not available. See [Air for Combustion and Ventilation](#), **Page 6**. If appliance keeps shutting off, see [Troubleshooting](#), **Page 24**.
13. Do not run appliance
  - where flammable liquids or vapors are used or stored
  - under dusty conditions
14. Do not use this appliance to cook food or burn paper or other objects.
15. Do not use this room heater if any part has been under water. Immediately call a qualified service technician to inspect the room heater and to replace any part of the control system and any gas control which has been under water.
16. Do not operate appliance if any log is broken. Do not operate appliance if a log is chipped (dime-sized or larger).
17. Turn heater off and let cool before servicing, installing, or repairing. Make sure the selector switch is in the OFF position. Only a qualified service person should install, service, or repair heater.
18. This heater must not be connected to any external electrical source.
19. Operating appliance above elevations of 4,500 feet may cause pilot outage.
20. Provide adequate clearances around air openings.
21. Solid fuels shall not be burned in a fireplace in which an unvented room heater is installed.
22. Follow the clearance requirements within this manual to assure adequate clearances for accessibility for purposes of servicing and proper operation.
23. Installation and the provisions for combustion and ventilation air must conform with the National Fuel Gas Code, ANSI Z223.1/NFPA 54.
24. When installing as a vented appliance in a manufactured home or mobile home, the installation must conform with the Manufactured Home Construction and Safety Standard, Title 24 CFR, Part 3280, or when applicable, with Manufacture Home Installations Standard, ANSI/NCBCS A225.1/NFPZ 501A.

## PRODUCT IDENTIFICATION

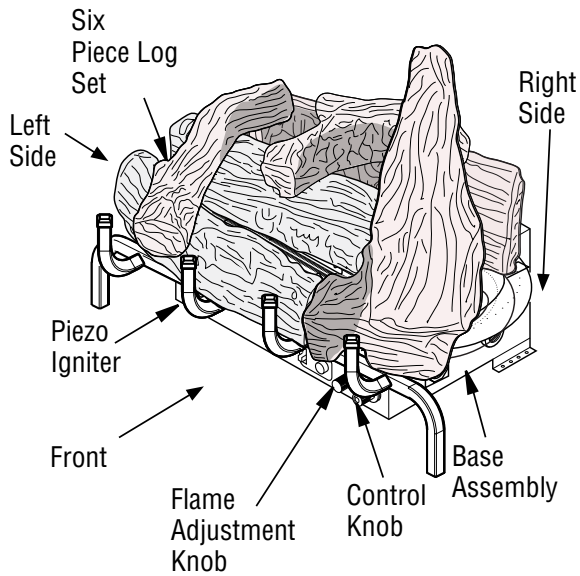

Figure 1 - Product Identification

## COMMONWEALTH OF MASSACHUSETTS REQUIREMENTS

These appliances are approved for installation in the US state of Massachusetts if the following additional requirements are met:

- Un-vented Room Heaters shall be installed in accordance with 527 CMR 30.
- Installation and repair must be done by a plumber or gas fitter licensed in the Commonwealth of Massachusetts.
- The flexible gas line connector used shall not exceed 36 inches (92 centimeters) in length.
- The individual manual shut-off must be a T-handle type valve.
- Unvented appliances may NOT be installed in bedrooms or bathrooms.
- A working smoke detector must be installed in the area where vent-free appliances are installed.

Seller of unvented propane or natural gas-fired supplemental room heaters shall provide to each purchaser a copy of 527 CMR 30 upon sale of the unit.

## LOCAL CODES

Install and use appliance with care. The installation must conform with local codes or in the absence of local codes, to the latest edition of The National Fuel Gas Code, ANSI Z223.1/NFPA54\*.

\*Available from:

American National Standards Institute, Inc.  
25 West 43rd Street, 4th floor  
New York, NY 10036  
National Fire Protection Association, Inc.  
1 Batterymarch Park  
Quincy, MA 02169-7471

**NOTE:** Where listed vented decorative logs are required, thermostat operation is not permitted.

## UNPACKING

1. Remove logs and heater base assembly from cartons.  
**NOTE:** Do not pick up heater base assembly by burners. This could damage heater. Always handle base assembly by grate.
2. Remove all protective packaging applied to logs and appliance for shipment.
3. Check appliance for any shipping damage. If appliance is damaged, promptly inform dealer where you purchased the appliance.

## PRODUCT FEATURES

### OPERATION

This heater is clean burning. It requires no outside venting. There is no heat loss out a vent or up a chimney. Heat is generated by both realistic flames and glowing coals. This heater is designed for vent-free operation with flue damper closed. It has been tested and approved to ANSI Z21.11.2 standard for unvented room heaters. State and local codes in some areas prohibit the use of unvented appliances. This heater may also be operated as a vented decorative (ANSI Z21.60) product by opening the flue damper.

### SAFETY DEVICE

This heater has a pilot with an Oxygen Depletion Sensing (ODS) safety shutoff system. The ODS/pilot is a required feature for vent-free room heaters. The ODS/pilot shuts off the heater if there is not enough fresh air.

### PIEZO IGNITION SYSTEM

This heater has a piezo igniter. This system requires no matches, batteries or other sources to light heater.

**CAUTION:** Do not remove the data plates from the grate assembly. The data plates contain important warranty and safety information.

## AIR FOR COMBUSTION AND VENTILATION

**⚠ WARNING: This heater shall not be installed in a room or space unless the required volume of indoor combustion air is provided by the method described in the National Fuel Gas Code, ANSI Z223.1/NFPA 54, the International Fuel Gas Code, or applicable local codes. Read the following instructions to ensure proper fresh air for this and other fuel-burning appliances in your home.**

Today's homes are built more energy efficient than ever. New materials, increased insulation and new construction methods help reduce heat loss in homes. Homeowners apply weather strip and caulk around windows and doors to keep the cold air out and the warm air in. During heating months, homeowners want their homes as airtight as possible.

While it is good to make your home energy efficient, your home needs to breathe. Fresh air must enter your home. All fuel-burning appliances need fresh air for proper combustion and ventilation.

Exhaust fans, some fireplaces, clothes dryers and some fuel-burning appliances draw air from the house to operate. You must provide adequate fresh air for these appliances. This will ensure proper venting of vented fuel-burning appliances.

### PROVIDING ADEQUATE VENTILATION

The following are excerpts from *National Fuel Gas Code, ANSI Z223.1/NFPA 54, Air for Combustion and Ventilation*.

All spaces in homes fall into one of the three following ventilation classifications:

1. Unusually Tight Construction
2. Unconfined Space
3. Confined Space

The information on **Pages 6-7** will help you classify your space and provide adequate ventilation.

#### Unusually Tight Construction

The air that leaks around doors and windows may provide enough fresh air for combustion and ventilation. However, in buildings of unusually tight construction, you must provide additional fresh air.

**Unusually tight construction is defined as construction where:**

- a. walls and ceilings exposed to the outside atmosphere have a continuous water vapor retarder with a rating of one perm ( $6 \times 10^{-11}$  kg per pa-sec- $m^2$ ) or less with openings gasketed or sealed and
- b. weather stripping has been added on openable windows and doors and
- c. caulking or sealants are applied to areas such as joints around window and door frames, between sole plates and floors, between wall-ceiling joints, between wall panels, at penetrations for plumbing, electrical and gas lines and at other openings.

If your home meets all three criteria above, you must provide additional fresh air. See *Ventilation Air From Outdoors, Page 7*.

If your home does not meet all three criteria above, proceed to *Determining Fresh-Air Flow For Heater Location*.

### Confined and Unconfined Space

The *National Fuel Gas Code, ANSI Z223.1/ NFPA54* allows two methods for determining whether the space in which the heater is being installed is confined or unconfined space. The standard method defines a confined space as a space whose volume is less than 50 cubic feet per 1,000 Btu/hr (4.8 m<sup>3</sup> per kw) of the aggregate input rating of all appliances installed in that space and an unconfined space as a space whose volume is not less than 50 cubic feet per 1,000 Btu/hr (4.8 m<sup>3</sup> per kw) of the aggregate input rating of all appliances installed in that space. Rooms communicating directly with the space in which the appliances are installed\*, through openings not furnished with doors, are considered a part of the unconfined space. Where the air infiltration rate of a structure is known, the Known Air Infiltration Rate Method may be used. Follow The National Fuel Gas Code, ANSI Z223.1/NFPA 54 to use this method to determine if the space is confined or unconfined.

\* Adjoining rooms are communicating only if there are doorless passageways or ventilation grills between them.

### DETERMINING FRESH-AIR FLOW FOR HEATER LOCATION

#### Determining if You Have a Confined or Unconfined Space Using the Standard Method

Use this work sheet to determine if you have a confined or unconfined space.

**Space:** Includes the room in which you will install fireplace plus any adjoining rooms with doorless passageways or ventilation grills between the rooms.

1. Determine the volume of the space (length x width x height).  
Length x Width x Height = \_\_\_\_\_ cu. ft. (volume of space)

**Example:** Space size 20 ft. (length) x 16 ft. (width) x 8 ft. (ceiling height) = 2560 cu. ft. (volume of space)

If additional ventilation to adjoining room is supplied with grills or openings, add the volume of these rooms to the total volume of the space.

2. Multiply the space volume by 20 to determine the maximum Btu/Hr the space can support.

\_\_\_\_\_ (volume of space) x 20 = (Maximum Btu/Hr the space can support)

**Example:** 2560 cu. ft. (volume of space) x 20 = 51,200 (maximum Btu/Hr the space can support)

3. Add the Btu/Hr of all fuel burning appliances in the space.

Vent-free fireplace \_\_\_\_\_ Btu/Hr  
Gas water heater\* \_\_\_\_\_ Btu/Hr  
Gas furnace \_\_\_\_\_ Btu/Hr  
Vented gas heater \_\_\_\_\_ Btu/Hr  
Gas fireplace logs \_\_\_\_\_ Btu/Hr  
Other gas appliances\* \_\_\_\_\_ + \_\_\_\_\_ Btu/Hr  
Total = \_\_\_\_\_ Btu/Hr

\* Do not include direct-vent gas appliances. Direct-vent draws combustion air from the outdoors and vents to the outdoors.

**Example:**

Gas water heater 40,000 Btu/Hr  
Vent-free fireplace + 33,000 Btu/Hr  
Total = 73,000 Btu/Hr

## AIR FOR COMBUSTION AND VENTILATION *Continued*

4. Compare the maximum Btu/Hr the space can support with the actual amount of Btu/Hr used.

\_\_\_\_\_ Btu/Hr (maximum can support)

\_\_\_\_\_ Btu/Hr (actual amount used)

**Example:** 51,200 Btu/Hr (maximum the space can support)  
73,000 Btu/Hr (actual amount of Btu/Hr used)

The space in the above example is a confined space because the actual Btu/Hr used is more than the maximum Btu/Hr the space can support. You must provide additional fresh air. Your options are as follows:

- Rework worksheet, adding the space of an adjoining room. If the extra space provides an unconfined space, remove door to adjoining room or add ventilation grills between rooms. See [Ventilation Air From Inside Building](#).
- Vent room directly to the outdoors. See [Ventilation Air From Outdoors](#).
- Install a lower Btu/Hr fireplace, if lower Btu/Hr size makes room unconfined.

If the actual Btu/Hr used is less than the maximum Btu/Hr the space can support, the space is an unconfined space. You will need no additional fresh air ventilation.

**⚠ WARNING:** If the area in which the heater may be operated does not meet the required volume for indoor combustion air, combustion and ventilation air shall be provided by one of the methods described in the *National Fuel Gas Code, ANSI Z223.1/NFPA 54*, the *International Fuel Gas Code*, or applicable local codes.

### VENTILATION AIR

#### Ventilation Air From Inside Building

This fresh air would come from an adjoining unconfined space. When ventilating to an adjoining unconfined space, you must provide two permanent openings: one within 12" of the ceiling and one within 12" of the floor on the wall connecting the two spaces (see *options 1 and 2, Figure 2*). You can also remove door into adjoining room (see *option 3, Figure 2*). Follow the *National Fuel Gas Code, ANSI Z223.1/NFPA 54, Air for Combustion and Ventilation* for required size of ventilation grills or ducts.

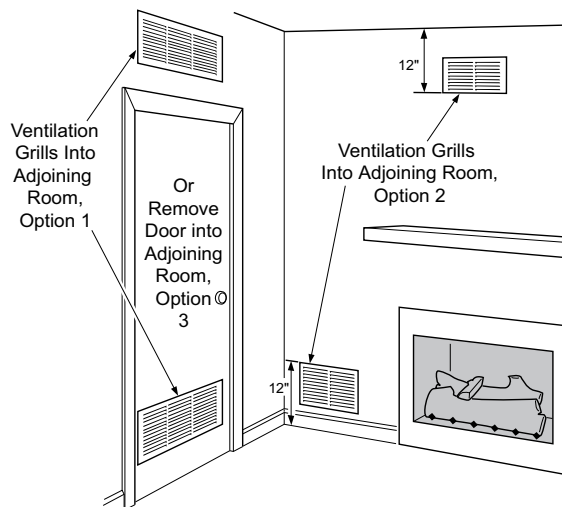
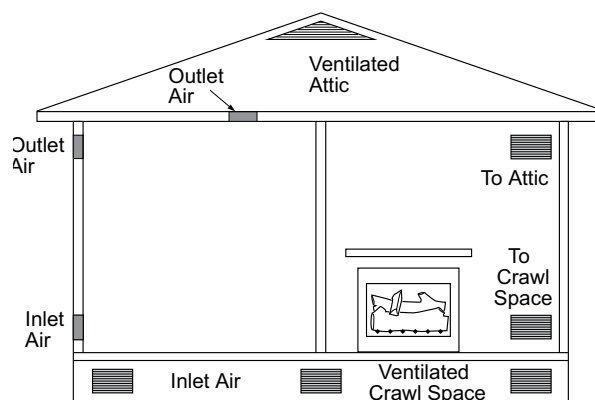

**Figure 2 - Ventilation Air from Inside Building**

#### Ventilation Air From Outdoors

Provide extra fresh air by using ventilation grills or ducts. You must provide two permanent openings: one within 12" of the ceiling and one within 12" of the floor. Connect these items directly to the outdoors or spaces open to the outdoors. These spaces include attics and crawl spaces. Follow the *National Fuel Gas Code, ANSI Z223.1/NFPA 54, Air for Combustion and Ventilation* for required size of ventilation grills or ducts.

**IMPORTANT:** Do not provide openings for inlet or outlet air into attic if attic has a thermostat-controlled power vent. Heated air entering the attic will activate the power vent.



**Figure 3 - Ventilation Air from Outdoors**

## INSTALLATION

**NOTICE:** This appliance is intended for supplemental heating. Use this heater along with your primary heating system. Do not install this heater as your primary heat source. If you have a central heating system, you may run system's circulating blower while using heater. This will help circulate the heat throughout the house. In the event of a power outage, you can use this heater as your primary heat source.

**⚠ WARNING:** A qualified service person must install heater. Follow all local codes.

**NOTICE:** State or local codes may only allow operation of this appliance in a vented configuration. Check your state or local codes.

**⚠ WARNING:** Before installing in a solid fuel burning fireplace, the chimney flue and firebox must be cleaned of soot, creosote, ashes and loose paint by a qualified chimney cleaner. Creosote will ignite if highly heated. A dirty chimney flue may create and distribute soot within the house. Inspect chimney and firebox flue for damage. If damaged, repair flue and firebox before operating heater.

**⚠ WARNING:** Any outside air ducts and/or ash dumps in the fireplace shall be permanently closed at time of appliance installation.

**⚠ WARNING:** Seal any fresh air vents or ash clean-out doors located on floor or wall of fireplace. If not, drafting may cause pilot outage or sooting. Use a heat-resistant sealant. Do not seal chimney flue damper.

**⚠ WARNING:** Never install the heater

- in a bedroom or bathroom unless installed as a vented appliance, see *Page 11*
- in a recreational vehicle
- where curtains, furniture, clothing or other flammable objects are less than 36" from front or 42" from top of heater. For side clearances see *Figure 4*
- in high traffic areas
- in windy or drafty areas

**⚠ CAUTION:** This heater creates warm air currents. These currents move heat to wall surfaces next to heater. Installing heater next to vinyl or cloth wall coverings or operating heater where impurities (such as, but not limited to, tobacco smoke, aromatic candles, cleaning fluids, oil or kerosene lamps, etc.) in the air exist, may discolor walls or cause odors.

**IMPORTANT:** Vent-free heaters add moisture to the air. Although this is beneficial, installing heater in rooms without enough ventilation air may cause mildew to form from too much moisture. See *Air for Combustion and Ventilation, Page 6*.

### CHECK GAS TYPE

Use the correct type of gas (natural or propane/LP). If your gas supply is not the correct gas type, do not install appliance. Call the dealer where you purchased the appliance for proper type appliance.

**⚠ WARNING:** This appliance is equipped for either natural gas or propane/LP gas but not both. Gas type is indicated on the rating plate. Field conversion is not permitted.

**⚠ WARNING:** If optional remote control is used, make sure the selector switch is in the OFF position before installing heater.

### INSTALLATION AND CLEARANCES FOR VENT-FREE OPERATION

**⚠ WARNING:** Maintain the minimum clearances. If you can, provide greater clearances from floor, ceiling and adjoining wall.

**MINIMUM FIREPLACE CLEARANCE TO COMBUSTIBLE MATERIALS**  
Side Wall 16", Ceiling 42", Front 36"

### LOG SIZING REQUIREMENTS

Log Size	Minimum Firebox			
	Height	Depth	Front Width	Rear * Width
18"	17"	13.5"	24"	20.5"
24"	17"	13.5"	28"	20.5"

\* Measured at 13.5" depth.

Carefully follow these instructions. This will ensure safe installation into a masonry, UL127-listed manufactured fireplace or listed vent-free firebox.



## INSTALLATION *Continued*

### Minimum Clearances For Side Combustible Material, Side Wall and Ceiling

- A. Clearances from the side of the fireplace cabinet to any combustible material and wall should follow diagram in **Figure 4**.  
**Example:** The face of a mantel, bookshelf, etc. is made of combustible material and protrudes 3-1/2" from the wall. This combustible material must be 4" from the side of the fireplace cabinet (see **Figure 4**).  
**NOTE:** When installing your gas logs into a manufactured firebox, follow firebox manufacturer's instructions for minimum clearances to combustible materials.
- B. Clearances from the top of the fireplace opening to the ceiling should not be less than 42".

**NOTICE:** Manual control heaters may be used as a vented product. If so, you must always run heater with chimney flue damper open. If running heater with damper open, noncombustible material above fireplace opening is not needed. Go to **Installing Damper Clamp Accessory for Vented Operation, Page 11**.

Maintain adequate clearances for accessibility for purposes of servicing and proper operation.

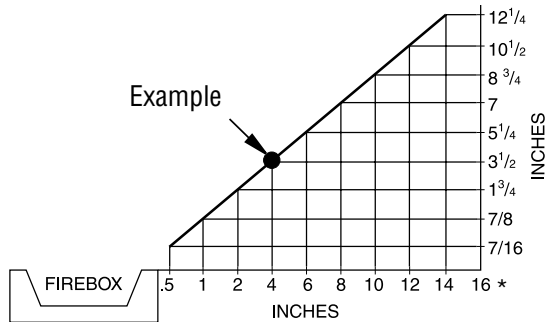

\*Minimum 16 inches from Side Wall

**Figure 4 - Minimum Clearance for Combustible to Wall**

### Minimum Noncombustible Material Clearances If Not Using Mantel

**NOTE:** If using a mantel proceed to **If Using Mantel**. If not using a mantel, follow the information on this page.

You must have noncombustible material(s) above the fireplace opening. Noncombustible materials (such as slate, marble, tile, etc.) must be at least 1/2 inch thick. With sheet metal, you must have noncombustible material behind it. Noncombustible material must extend at least 8" up (for all models). If noncombustible material is less than 12", you must install the fireplace hood accessory (for all models). See **Figure 5** for minimum clearances.

Noncombustible Material Distance (A)	Requirements for Safe Installation
12" or more	Noncombustible material okay.
Between 8" and 12"	Install fireplace hood accessory (GA6050 - see <b>Accessories, Page 33</b> ).
Less than 8"	Noncombustible material must be extended to at least 8". See <b>Between 8" and 12"</b> , above. If you cannot extend material, you must operate heater with flue damper open.

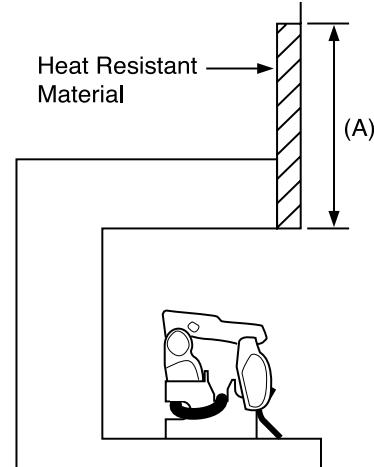

**Figure 5 - Heat Resistant Material (Slate, Marble, Tile, etc.) Above Fireplace**

Minimum clearance requirements include any projections such as shelves, window sills, mantels, etc. above the appliance.

### If Using Mantel

You must have noncombustible material(s) above the fireplace opening. Noncombustible materials (such as slate, marble, tile, etc.) must be at least 1/2" thick. With sheet metal, you must have noncombustible material behind it. Noncombustible material must extend at least 8 inches up (for all models). If noncombustible material is less than 12", you must install the fireplace hood accessory (24" Models Only). Even if noncombustible material is more than 12", you may need the hood accessory to deflect heat away from your mantel shelf. See **Figure 5**, this page and **Figures 6 & 7 (Page 10)** for minimum clearances.

**IMPORTANT:** If you cannot meet these minimum clearances, you must operate heater with chimney flue damper open. Go to **Installing Damper Clamp Accessory for Vented Operation, Page 11**.

### MANTEL CLEARANCES

In addition to meeting noncombustible material clearances, you must also meet required clearances between fireplace opening and mantel shelf. If you do not meet the clearances listed below, you will need a hood.

#### Determining Minimum Mantel Clearance

If you meet minimum clearance between mantel shelf and top of fireplace opening, a hood is not required (see **Figure 6, page 10**).

## INSTALLATION *Continued*

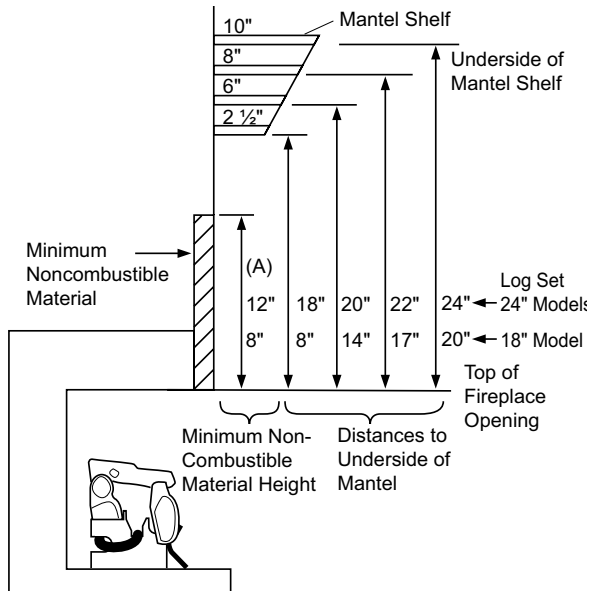

**Figure 6 - Minimum Mantel Clearances Without Using Hood**

### Determining Minimum Mantel Clearance When Using a Hood

If minimum clearances in **Figure 6**, are not met, you must have a hood. When using a hood there are still certain minimum mantel clearances required. Follow minimum clearances shown in **Figure 7** when using hood.

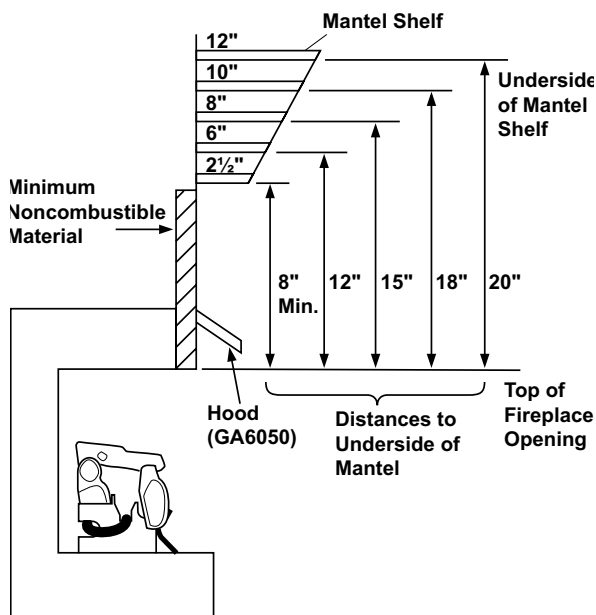

**Figure 7 - Minimum Mantel Clearances When Using Hood**

**NOTICE:** Surface temperatures of adjacent walls and mantels become hot during operation. Walls and mantels above the firebox may become hot to the touch. If installed properly, these temperatures meet the requirement of the national product standard. Follow all minimum clearances shown in this manual.

**Notice:** If your installation does not meet the minimum clearances shown, you must do one of the following:

- operate the logs only with the flue damper open
- raise the mantel to an acceptable height
- remove the mantel

### FLOOR CLEARANCES

- If installing appliance on the floor level, you must maintain the minimum distance of 14" to combustibles (*see Figure 8*).
- If combustible materials are less than 14" to the fireplace, you must install appliance at least 5" above the top surface of combustible flooring including tile and carpet (*see Figure 9*).

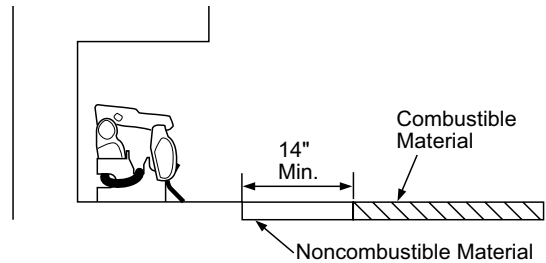

**Figure 8 - Minimum Fireplace Clearances If Installed at Floor Level**

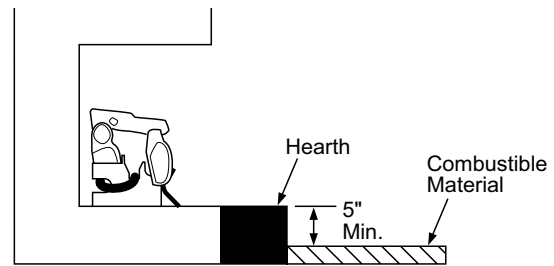

**Figure 9 - Minimum Fireplace Clearances Above Combustible Flooring**

## INSTALLATION *Continued*

### INSTALLING DAMPER CLAMP ACCESSORY FOR VENTED OPERATION

**NOTE:** When used as a vented heater, appliance must be installed only in a solid-fuel burning fireplace with a working flue and constructed of noncombustible material.

**For Massachusetts Residents Only:** Installation of this vented gas log set in the Commonwealth of Massachusetts requires the damper be permanently removed or welded in the fully open position.

If your heater is a manually-controlled model, you may use this heater as a vented product. There are three reasons for operating your heater in the vented mode.

1. The fireplace does not meet the clearance to combustibles requirements for vent-free operation.
2. State or local codes do not permit vent-free operation.
3. You prefer vented operation.

If reasons number 1 or 2 apply to you, you must permanently open chimney flue damper. You must install the damper clamp accessory (to order, see [Accessories, Page 33](#)). This will ensure vented operation (see [Figure 10](#)). The damper clamp will keep damper open. Installation instructions are included with clamp accessory.

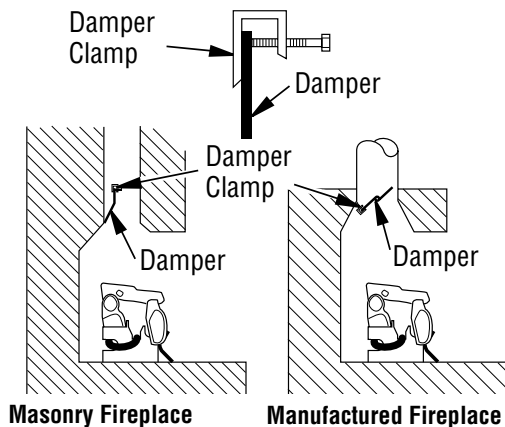

**Figure 10 - Attaching Damper Clamp**

See chart for minimum permanent flue opening you must provide. Attach damper clamp so the minimum permanent flue opening will be maintained at all times.

Area of Various Standard Round Flues	
Diameter	Area
5"	20 sq. in.
6"	29 sq. in.
7"	39 sq. in.
8"	51 sq. in.

Chimney Height	Minimum Permanent Flue Opening
6' to 15'	39 sq. in.
15' to 30'	29 sq. in.

### INSTALLING HEATER BASE ASSEMBLY

**⚠ WARNING:** You must secure this heater to fireplace floor. If not, heater will move when you adjust controls. Moving heater may cause a gas leak or log misplacement.

**⚠ WARNING:** If installing in a sunken fireplace, special care is needed. You must raise the fireplace floor to allow access to heater control panel. This will ensure adequate air flow and guard against sooting and controls being damaged. Raise fireplace floor with noncombustible material. Make sure material is secure.

**⚠ CAUTION:** Do not pick up heater base assembly by burners. This could damage heater. Only handle base assembly by grates.

**IMPORTANT:** Make sure the heater burners are level. If heater is not level, heater will not work properly.

#### Installation Items Needed

- hardware package (provided with heater)
- approved flexible gas hose and fittings (if allowed by local codes)
- sealant (resistant to propane/LP gas, not provided)
- electric drill with 3/16" drill bit (metal or masonry as applicable)
- flathead screwdriver
- pipe wrench

1. Connect approved flexible gas hose to gas control fitting in heater (see [Figure 11, Page 12](#)).

**IMPORTANT:** Hold gas fitting with wrench when connecting flexible gas hose.

2. Locate two masonry screws in hardware package.
3. Place heater base in fireplace.
4. Place logs in their proper position on heater base (see [Installing Logs, Page 14](#)).
5. Center heater base and logs front-to-back and side-to-side in fireplace.
6. Carefully remove logs without moving heater base.
7. Mark screw locations through one hole on each side of the mounting bracket (see [Figure 12, Page 12](#)). If installing in a brick-bottom fireplace, mark screw locations in mortar joint of bricks.

## INSTALLATION *Continued*

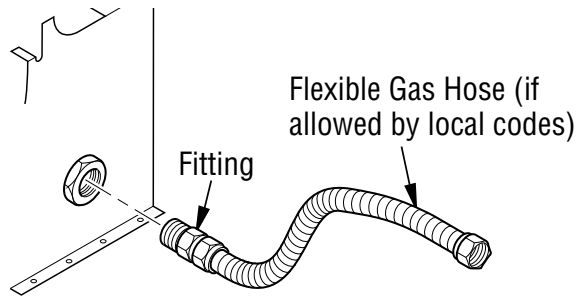

**Figure 11 - Attaching Flexible Gas Hose to Heater**

8. Remove heater base from fireplace. If installing optional control accessories, do so at this time. Follow all directions provided with accessory.
9. Drill holes at marked locations using 3/16" drill bit.
10. Attach base assembly to fireplace floor using two masonry screws (in hardware package).

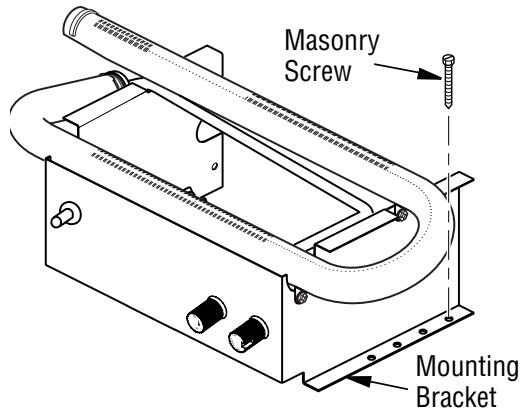

**Figure 12 - Attaching Base to Fireplace Floor**

### CONNECTING TO GAS SUPPLY

**⚠ WARNING:** This appliance requires a 3/8" NPT (National Pipe Thread) inlet connection to the pressure regulator.

**⚠ WARNING:** A qualified service person must connect heater to gas supply. Follow all local codes.

**⚠ CAUTION:** Never connect propane/LP fireplace directly to the propane/LP supply. This heater requires an external regulator (not supplied). Install the external regulator between the heater and propane/LP supply.

**⚠ WARNING:** Never connect this appliance to private (non-utility) gas wells. This gas is commonly known as wellhead gas and does not have odorants and may have impurities, and variations in BTU content. The use of well-head gas will void the manufacturer's warranty to this appliance.

### Installation Items Needed

Before installing heater, make sure you have the items listed below.

- external regulator (supplied by installer)
- piping (check local codes)
- sealant (resistant to propane/LP gas)
- equipment shutoff valve
- test gauge connection
- sediment trap
- tee joint
- pipe wrench

For propane/LP units, the installer must supply an external regulator. The external regulator will reduce incoming gas pressure. You must reduce incoming gas pressure to between 11" and 14" of water. If you do not reduce incoming gas pressure, heater regulator damage could occur. Install external regulator with the vent pointing down as shown in **Figure 13**. Pointing the vent down protects it from freezing rain or sleet.

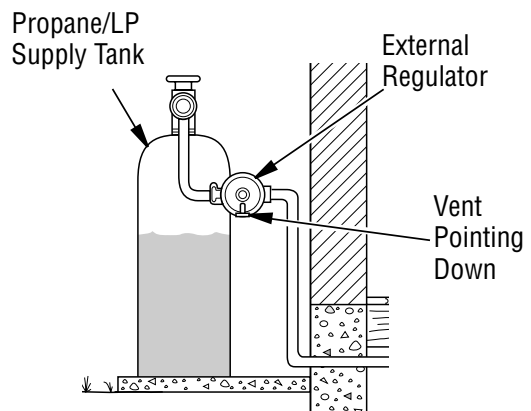

**Figure 13 - External Regulator With Vent Pointing Down**

**⚠ WARNING:** Never connect natural gas fireplace to private (non-utility) gas wells. This gas is commonly known as wellhead gas.

**⚠ CAUTION:** Use only new, black iron or steel pipe. Internally-tinned copper tubing may be used in certain areas. Check your local codes. Use pipe of 1/2" diameter or greater to allow proper gas volume to heater. If pipe is too small, undue loss of volume will occur.

## INSTALLATION *Continued*

Installation must include an equipment shutoff valve, union and plugged 1/8" NPT tap. Locate NPT tap within reach for test gauge hook up. NPT tap must be upstream from heater (see **Figure 14**).

**IMPORTANT:** Install equipment shutoff valve in an accessible location. The equipment shutoff valve is for turning on or shutting off the gas to the appliance.

Check your building codes for any special requirements for locating equipment shutoff valve to fireplaces.

Apply pipe joint sealant lightly to male NPT threads. This will prevent excess sealant from going into pipe. Excess sealant in pipe could result in clogged heater valves.

**WARNING:** Use pipe joint sealant that is resistant to liquid petroleum (LP) gas.

We recommend that you install a sediment trap in supply line as shown in **Figure 14**. Locate sediment trap where it is within reach for cleaning. Install in piping system between fuel supply and heater. Locate sediment trap where trapped matter is not likely to freeze. A sediment trap traps moisture and contaminants. This keeps them from going into heater controls. If sediment trap is not installed or is installed wrong, heater may not run properly.

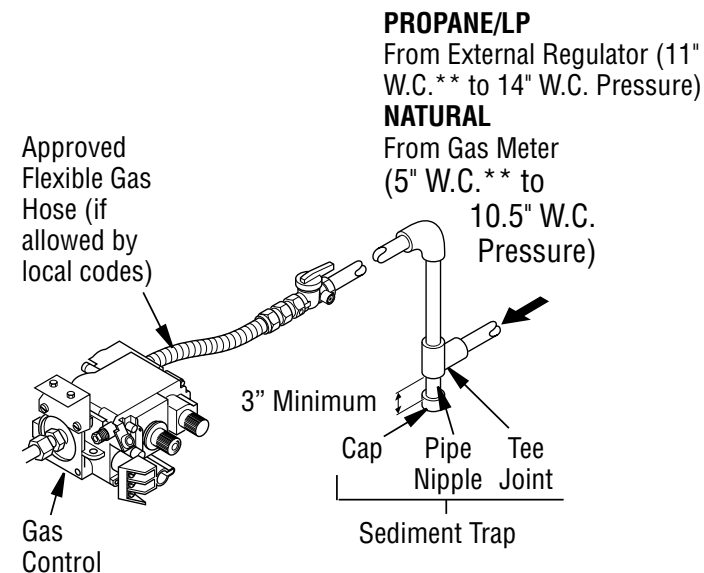

\*\* Minimum inlet pressure for purpose of input adjustment.

**Figure 14 - Gas Connection**

**CAUTION:** Avoid damage to regulator. Hold gas regulator with wrench when connecting it to gas piping and/or fittings.

## CHECKING GAS CONNECTIONS

**WARNING:** Test all gas piping and connections, internal and external to unit, for leaks after installing or servicing. Correct all leaks at once.

**WARNING:** Never use an open flame to check for a leak. Apply a noncorrosive leak detection fluid to all joints. Bubbles forming show a leak. Correct all leaks at once.

**CAUTION:** Make sure external regulator has been installed between propane/LP supply and heater. See guidelines under **Connecting to Gas Supply, Page 12**.

## PRESSURE TESTING GAS SUPPLY PIPING SYSTEM

The appliance and its appliance main gas valve must be disconnected from the gas supply piping system during any pressure testing of that system at test pressures **in excess of** 1/2 psi (3.5 kPa).

The appliance must be isolated from the gas supply piping system by closing its equipment shutoff valve during any pressure testing of the gas supply piping system at test pressures **equal to or less than** 1/2 psi (3.5 kPa).

### Test Pressures In Excess Of 1/2 PSIG (3.5 kPa)

1. Disconnect appliance with its appliance main gas valve (control valve) and equipment shutoff valve from gas supply piping system. Pressures in excess of 1/2 psig (3.5 kPa) will damage heater regulator.
2. Cap off open end of gas pipe where equipment shutoff valve was connected.
3. Pressurize supply piping system by either opening propane/LP supply tank valve for propane/LP gas or opening main gas valve located on or near gas meter for natural gas or using compressed air.
4. Check all joints of gas supply piping system. Apply noncorrosive leak detection fluid to all joints. Bubbles forming show a leak.
5. Correct all leaks at once.
6. Reconnect heater and equipment shutoff valve to gas supply. Check reconnected fittings for leaks.

### Test Pressures Equal To or Less Than 1/2 PSIG (3.5 kPa)

1. Close equipment shutoff valve (see **Figure 15, page 14**).
2. Pressurize supply piping system by either opening propane/LP supply tank valve for propane/LP gas or opening main gas valve located on or near gas meter for natural gas or using compressed air.
3. Check all joints from gas meter to equipment shutoff valve for natural gas or propane/LP supply to equipment shutoff valve for propane/LP (see **Figures 16 and 17, page 14**). Apply noncorrosive leak detection fluid to all joints. Bubbles forming show a leak.
4. Correct all leaks at once.

## INSTALLATION *Continued*

### PRESSURE TESTING HEATER GAS CONNECTIONS

1. Open equipment shutoff valve (see **Figure 17**).
2. Open main gas valve located on or near gas meter for natural gas or open propane/LP supply tank valve.
3. Make sure control knob of heater is in the OFF position.
4. Check all joints from equipment shutoff valve to gas control (see **Figures 16 and 17**). Apply noncorrosive leak detection fluid to all joints. Bubbles forming show a leak.
5. Correct all leaks at once.
6. Light heater (see **Operation, Page 20**). Check all other internal joints for leaks.
7. Turn off heater (see **To Turn Off Gas to Appliance, Page 21**).

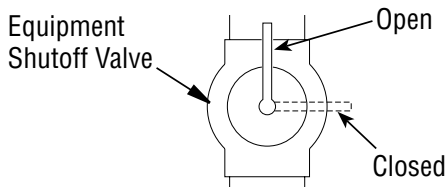

**Figure 15 - Equipment Shutoff Valve**

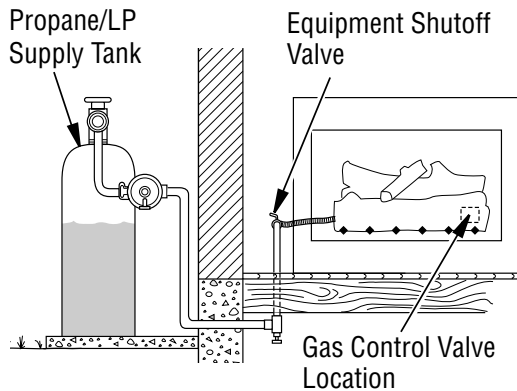

**Figure 16 - Checking Gas Joints (Propane/LP Model Shown)**

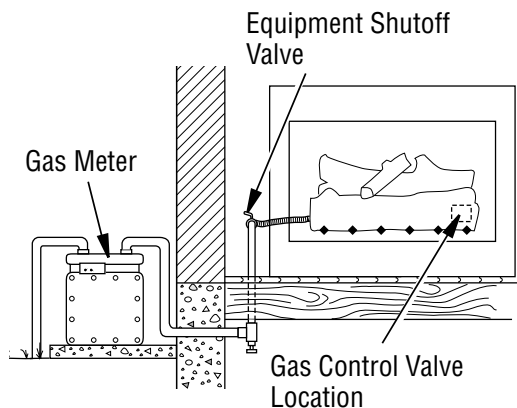

**Figure 17 - Checking Gas Joints (Natural Gas Only)**

### INSTALLING LOGS

**⚠ WARNING:** Failure to position the parts in accordance with these diagrams or failure to use only parts specifically approved with this heater may result in property damage or personal injury. See Instruction Manual for further information.

**⚠ WARNING:** Fireplace screens must be closed while the appliance is in operation.

**⚠ CAUTION:** After installation and periodically thereafter, check to ensure that no flame comes in contact with any log. With the heater set to HI, check to see if flames contact any log. If so, reposition logs according to the log installation instructions in this manual. Flames contacting logs will create soot.

See owners manual for additional log placement information.

## INSTALLATION *Continued*

### CHESTNUTH18CH, CHESTNUTH24CH, CHESTNUTHILLHD18 AND CHESTNUTHILLHD24

It is very important to install these logs exactly as instructed. Do not modify logs. Only use logs supplied with this appliance.

1. Install rear log on chassis using the two weld pins and corresponding holes in log (see Figures A and B).



**Figure A - Rear Log Placement**



**Figure B - Install Rear Log**

2. Install middle log on chassis using the two weld pins and corresponding holes in log (see Figures C and D).



**Figure C - Middle Log Placement**



**Figure D - Install Middle Log**

## INSTALLATION *Continued*

3. Install front log on chassis between burner and grate fingers. Align far right side grate finger on log slot on under top knot (see detail). (see Figures E and F).
4. Install top right log by placing round hole in log to raised round protrusion on rear log and placing square hole in log to raised square protrusion on front log (see Figures G and H).

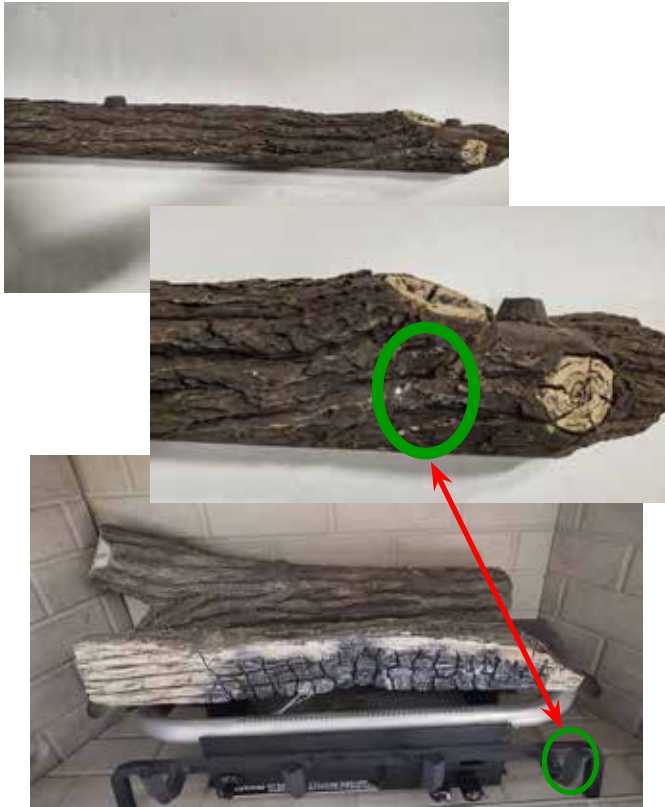

**Figure E - Front Log Placement**



**Figure F - Install Front Log**

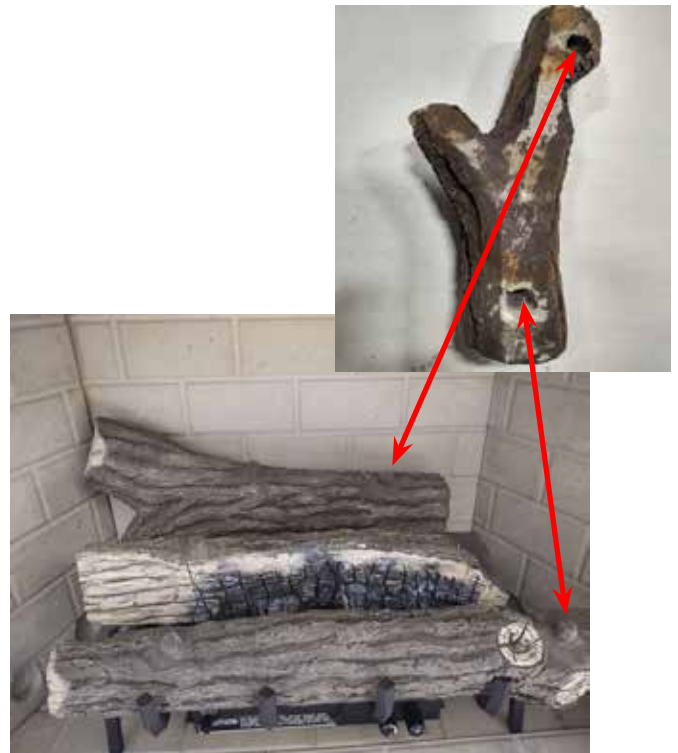

**Figure G - Top Right Log Placement**

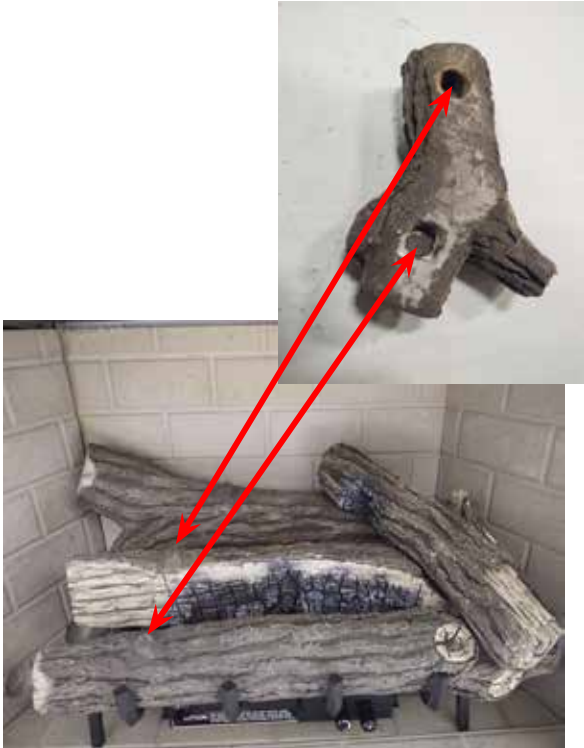

**Figure H - Install Right Top Log**



## INSTALLATION *Continued*

5. Install top left log by placing square hole on square raised protrusion on front log and placing round hole on round raised protrusion on middle log (see Figures J and K).



**Figure J - Top Left Log Placement**



**Figure K - Install Top Left Log**

6. Install top middle log by placing square hole on square raised protrusion on rear log then position the front of the log on the landing on the middle log (see Figures L and M).



**Figure L - Top Middle Log Placement**



**Figure M - Install Top Middle Log**



**Final Setup**

## INSTALLATION *Continued*

### BLONDEOAK18 AND BLONDEOAK24

It is very important to install these logs exactly as instructed. Do not modify logs. Only use logs supplied with heater.

1. Install rear log on chassis using the two weld pins and corresponding holes in log (see Figure 1).

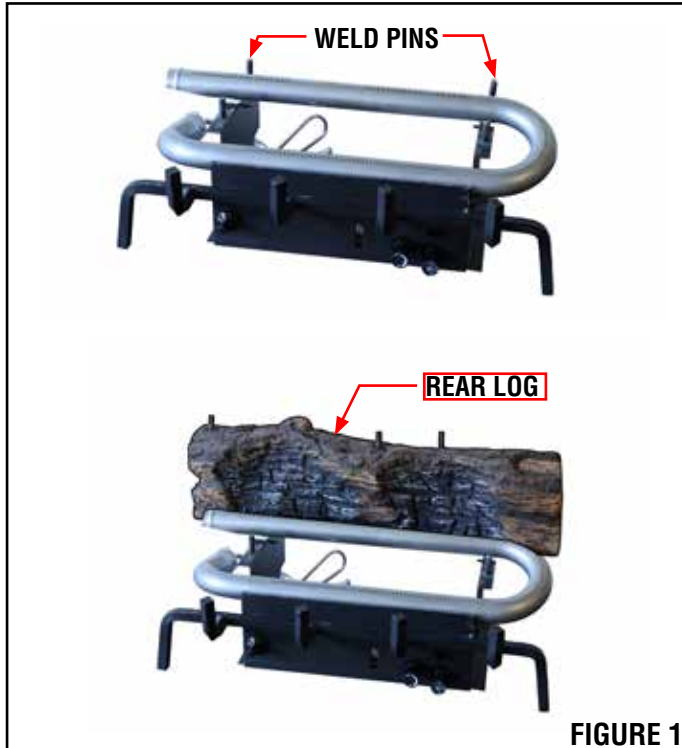

2. Install middle log on chassis using the two weld pins and corresponding holes in log (see Figure 2).

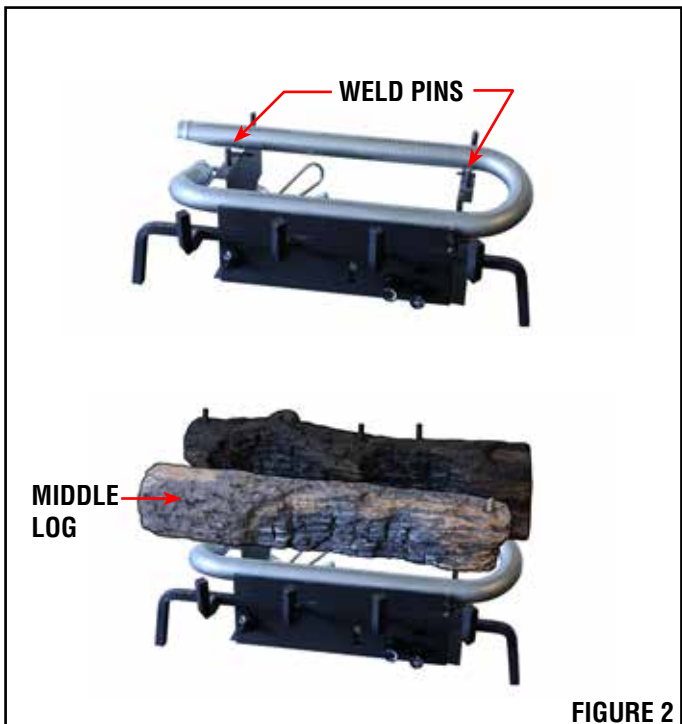

3. Install front log between burner and grate fingers. Align the left side grate finger on log slot (see Figure 3).

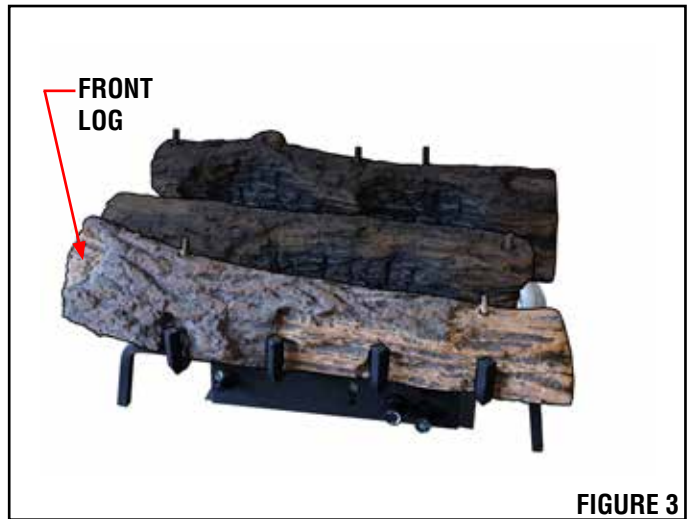

4. Install top middle log using the two last protrusions in the rear log (see Figure 4).



5. Install top right log using the last protrusions in both the middle and front log (see Figure 5).

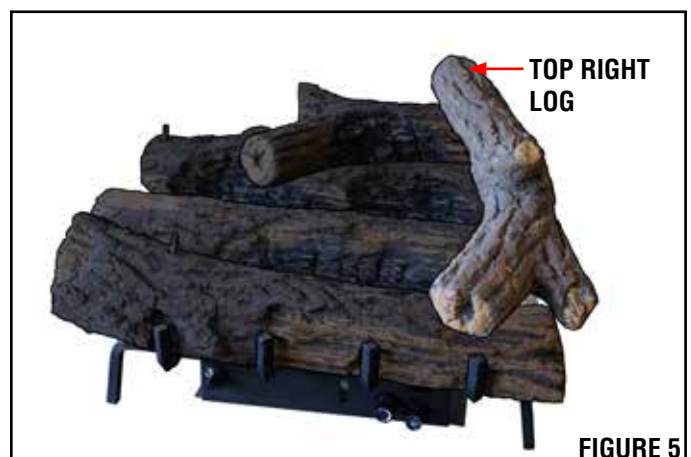

## INSTALLATION *Continued*

6. Install top left log using the two first protrusions in both the rear and middle log (see *Figure 6*).

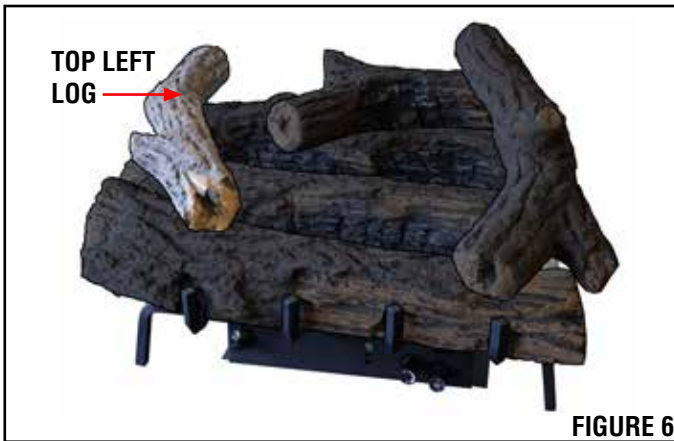

After setting the logs into position as described above, ensure each is properly and firmly seated. The vent-free gas log set will not function as intended if the logs are not correctly positioned. When placed properly, the flames will not strike any portion of the logs. Periodically check the positioning of all logs to ensure proper log placement and stability. If any flame is striking the logs, recheck log placement. Adjust to conform with instructions. There should be no flame impingement on the logs.

INSTALLATION IS NOW COMPLETE



## OPERATION

### FOR YOUR SAFETY READ BEFORE LIGHTING

**⚠ WARNING:** If you do not follow these instructions exactly, a fire or explosion may result causing property damage, personal injury or loss of life.

- A. This appliance has a pilot which must be lighted by hand. When lighting the pilot, follow these instructions exactly.
- B. **BEFORE LIGHTING** smell all around the appliance area for gas. Be sure to smell next to the floor because some gas is heavier than air and will settle on the floor.
- WHAT TO DO IF YOU SMELL GAS**
- Do not try to light any appliance.
  - Do not touch any electric switch; do not use any phone in your building.
  - Immediately call your gas supplier from a neighbor's phone. Follow the gas supplier's instructions.
  - If you cannot reach your gas supplier, call the fire department.
- C. Use only your hand to push in or turn the gas control knob. Never use tools. If the knob will not push in or turn by hand, don't try to repair it, call a qualified service technician or gas supplier. Force or attempted repair may result in a fire or explosion.
- D. Do not use this appliance if any part has been under water. Immediately call a qualified service technician to inspect the appliance and to replace any part of the control system and any gas control which has been under water.

### LIGHTING INSTRUCTIONS

**⚠ WARNING:**

- If fireplace has glass doors, never operate this heater with glass doors closed. If you operate heater with doors closed, heat buildup inside fireplace will cause glass to burst. Make sure there are no obstructions across opening of fireplace.
- You must operate this heater with a fireplace screen in place. Make sure fireplace screen is closed before running heater. The fireplace screen shall have openings for introduction of combustion air.



**NOTICE:** During initial operation of new heater, burning logs will give off a paper-burning smell. Orange flame will also be present. Open damper or window to vent smell. This will only last a few hours.

*NOTE: Homeowners generally prefer to operate their heater with the chimney damper closed. This will put all the heat into the room. However, there may be times you will desire the full flames of the HI heat setting but will find the heat output excessive. You can open the chimney damper (if you have one) fully or partially to release some of the heat.*

**⚠ WARNING:** Damper handle will be hot if heater has been running.

1. STOP! Read the safety information in the left column.
2. Make sure equipment shutoff valve is fully open.
3. If equipped with a remote control, set selector switch in the OFF position.

**⚠ WARNING:** Burners will come on automatically within one minute when the selector switch is in the ON position after the pilot is lit.

4. Press in and turn control knob clockwise  to the OFF position (see **Figure 28, Page 21**).
5. Wait five (5) minutes to clear out any gas. Then smell for gas, including near the floor. If you smell gas, STOP! Follow "B" in the safety information, **on this Page**. If you don't smell gas, go to the next step.
6. Press in and turn control knob counterclockwise  to the PILOT position. Press in control knob for five (5) seconds (see **Figure 28, Page 21**).

*NOTE: You may be running this heater for the first time after hooking up to gas supply. If so, the control knob may need to be pressed in for 30 seconds or more. This will allow air to bleed from the gas system.*

## OPERATION *Continued*

7. With control knob pressed in, press and release igniter button. This will light pilot. The pilot is attached to the front burner. If needed, keep pressing igniter button until pilot lights.

**NOTE:** If pilot does not stay lit, contact a qualified service person or gas supplier for repairs. Until repairs are made, light pilot with match. To light pilot with match, see *Manual Lighting Procedure*.

8. Keep control knob pressed in for 30 seconds after lighting pilot. After 30 seconds, release control knob.

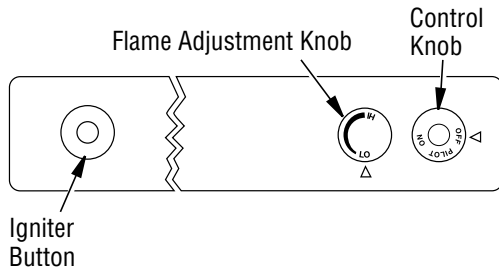

**Figure 28 - Control Knob and Igniter Button Location (Shown as Supplied, No Control Options)**

- If control knob does not pop out when released, contact a qualified service person or gas supplier for repairs.

**NOTE:** If pilot goes out, repeat steps 4 through 8.

9. Slightly push in and turn control knob counterclockwise to the ON position.
10. Wait one minute and switch selector switch, if optional remote control is used, to the ON position to light burners.  
**NOTE:** AUTO is only functional when using GWM1 or GWMS2 optional accessories.
11. Set flame adjustment knob to any level between HI and LO.
12. To leave pilot lit and shut off burners only: turn control knob clockwise to the PILOT position, or use remote control manual OFF button, or set selector switch in the OFF position.

**CAUTION:** Do not try to adjust heating levels by using the equipment shutoff valve.

**WARNING:** If optional remote control is used, make sure the selector switch is in the OFF position when you are away from home for long periods of time. Heater will come on automatically with selector switch in the ON position.

## TO TURN OFF GAS TO APPLIANCE

1. Turn control knob clockwise to the OFF position.
2. If Using Optional Hand-Held Remote: Set selector switch in the OFF position to prevent draining battery.
3. Close equipment shutoff valve (see **Figure 15, Page 14**).

## MANUAL LIGHTING PROCEDURE

1. Follow steps 1 through 6 under *Lighting Instructions, Page 20*.
2. Depress control knob and light pilot with match.
3. Keep control knob pressed in for 30 seconds after lighting pilot. After 30 seconds, release control knob. Now follow steps 9 through 11 under *Lighting Instructions*.

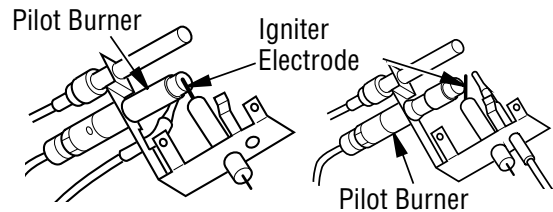

**Figure 29 - Pilot (Propane/LP)**

**Figure 30 - Pilot (Natural)**

## INSPECTING BURNERS

Check pilot flame pattern and burner flame patterns often.

### PILOT FLAME PATTERN

**Figure 31** shows a correct pilot flame pattern. **Figure 32** shows an incorrect pilot flame pattern. The incorrect pilot flame is not touching the thermocouple. This will cause the thermocouple to cool. When the thermocouple cools, the heater will shut down.

If pilot flame pattern is incorrect, as shown in **Figure 32**

- turn heater off (see [To Turn Off Gas to Appliance, Page 21](#))
- see [Troubleshooting, Page 24](#)

**NOTE:** The pilot flame on natural gas units will have a slight curve, but flame should be blue and have no yellow or orange color.

### BURNER PRIMARY AIR HOLES

Air is drawn into the burner through the holes in the fitting at the burner entrance. These holes may become blocked with dust or lint. Periodically inspect these holes for any blockage and clean if needed. Blocked air holes will create soot.

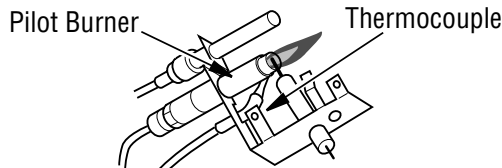

**Figure 31 - Correct Pilot Flame Pattern (Your pilot may vary from pilot shown)**

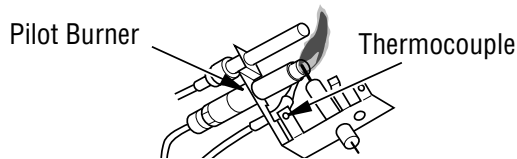

**Figure 32 - Incorrect Pilot Flame Pattern (Your pilot may vary from pilots shown)**

### MAIN BURNER

Periodically inspect all burner flame holes with the heater running. All slotted burner flame holes should be open with yellow flame present. All round burner flame holes should be open with a small blue flame present. Some burner flame holes may become blocked by debris or rust, with no flame present. If so, turn off heater and let cool. Remove blockage. Blocked burner flame holes will create soot.

## CLEANING AND MAINTENANCE

**WARNING:** Turn off heater and let cool before cleaning.

**CAUTION:** You must keep control areas, burners and circulating air passageways of heater clean. Inspect these areas of heater before each use. Have heater inspected yearly by a qualified service person. Heater may need more frequent cleaning due to excessive lint from carpeting, pet hair, bedding material, etc.

**WARNING:** Failure to keep the primary air opening(s) of the burner(s) clean may result in sooting and property damage.

Perform a periodic visual check of pilot and burner flame.

### BURNER ORIFICE HOLDER AND PILOT AIR INLET HOLE

The primary air inlet holes allow the proper amount of air to mix with the gas. This provides a clean burning flame. Keep these holes clear of dust, dirt, lint and pet hair. Clean these air inlet holes prior to each heating season. Blocked air holes will create soot. We recommend that you clean the unit every three months during operation and have heater inspected yearly by a qualified service person.

We also recommend that you keep the burner tube and pilot assembly clean and free of dust and dirt. To clean these parts we recommend using compressed air no greater than 30 PSI. Your local computer store, hardware store or home center may carry compressed air in a can. If using compressed air in a can, please follow the directions on the can. If you don't follow directions on the can, you could damage the pilot assembly.

1. Shut off the unit, including the pilot. Allow the unit to cool for at least thirty minutes.
2. Inspect burner, pilot and primary air inlet holes on Orifice holder for dust and dirt (see [Figures 33 and 34, page 23](#)).
3. Blow air through the ports/slots and holes in the burner.
4. Check the Orifice holder located at the end of the burner tube again. Remove any large particles of dust, dirt, lint or pet hair with a soft cloth or vacuum cleaner nozzle.
5. Blow air into the primary air holes on the Orifice holder.
6. In case any large clumps of dust have now been pushed into the burner repeat steps 3 and 4.

## CLEANING AND MAINTENANCE *Continued*

Clean the pilot assembly also. A yellow tip on the pilot flame indicates dust and dirt in the pilot assembly. There is a small pilot air inlet hole about two inches from where the pilot flame comes out of the pilot assembly (see **Figure 34**). With the unit off, lightly blow air through the air inlet hole. You may blow through a drinking straw if compressed air is not available.

### LOGS

- If you remove logs for cleaning, refer to *Installing Logs, Page 14*, to properly replace logs.
- Replace log(s) if broken or chipped (dime-sized or larger).

### MAIN BURNER

Periodically inspect all burner flame holes with the heater running. All slotted burner flame holes should be open with yellow flame present. All round burner flame holes should be open with a small blue flame present. Some burner flame holes may become blocked by debris or rust, with no flame present. If so, turn off heater and let cool. Remove blockage. Blocked burner flame holes will create soot.

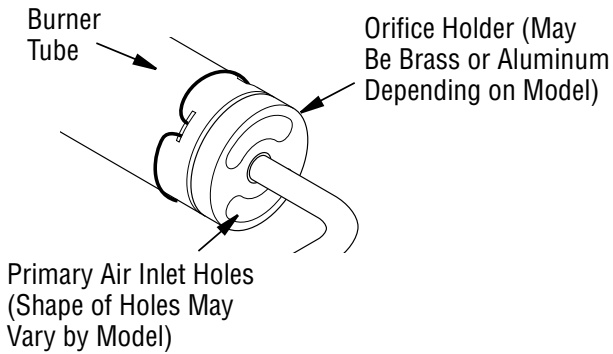

**Figure 33 - Orifice Holder On Outlet Burner Tube**

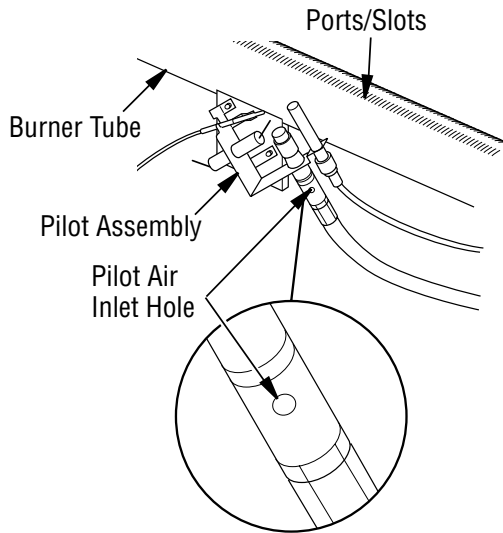

**Figure 34 - Pilot Inlet Air Hole**

## TROUBLESHOOTING

**⚠ WARNING:** Turn off heater and let cool before servicing. Only a qualified service person should service and repair heater.

**⚠ CAUTION:** Never use a wire, needle or similar object to clean ODS/pilot. This can damage ODS/pilot unit.

**NOTE:** All troubleshooting items are listed in order of operation.

OBSERVED PROBLEM	POSSIBLE CAUSE	REMEDY
When igniter button is pressed, there is no spark at ODS/pilot	<ol style="list-style-type: none"> <li>1. Igniter electrode not connected to igniter cable</li> <li>2. Igniter cable pinched or wet</li> <li>3. Piezo igniter nut is loose</li> <li>4. Broken igniter cable</li> <li>5. Bad piezo igniter</li> <li>6. Igniter electrode positioned wrong</li> <li>7. Igniter electrode broken</li> </ol>	<ol style="list-style-type: none"> <li>1. Reconnect igniter cable</li> <li>2. Free igniter cable if pinched by any metal or tubing. Keep igniter cable dry</li> <li>3. Tighten nut holding piezo igniter to base panel of log set. Nut is located behind base panel</li> <li>4. Replace igniter cable</li> <li>5. Replace piezo igniter</li> <li>6. Replace pilot assembly</li> <li>7. Replace pilot assembly</li> </ol>
When igniter button is pressed, there is spark at ODS/pilot but no ignition	<ol style="list-style-type: none"> <li>1. Gas supply turned off or equipment shutoff valve closed</li> <li>2. Control knob not in PILOT position</li> <li>3. Control knob not pressed in while in PILOT position</li> <li>4. Air in gas lines when installed</li> <li>5. Depleted gas supply (propane/LP only)</li> <li>6. ODS/pilot is clogged</li> <li>7. Gas regulator setting is not correct</li> </ol>	<ol style="list-style-type: none"> <li>1. Turn on gas supply or open equipment shutoff valve</li> <li>2. Turn control knob to PILOT position</li> <li>3. Press in control knob while in PILOT position</li> <li>4. Continue holding down control knob. Repeat igniting operation until air is removed</li> <li>5. Contact local propane/LP gas company</li> <li>6. Clean ODS/pilot (<i>see <a href="#">Cleaning and Maintenance, Page 22</a></i>) or replace ODS/pilot assembly</li> <li>7. Replace gas regulator</li> </ol>
ODS/pilot lights but flame goes out when control knob is released	<ol style="list-style-type: none"> <li>1. Control knob not fully pressed in</li> <li>2. Control knob not pressed in long enough</li> <li>3. Safety interlock system has been triggered</li> <li>4. Equipment shutoff valve not fully open</li> <li>5. Pilot flame not touching thermocouple, which allows thermocouple to cool, causing pilot flame to go out. This problem could be caused by one or both of the following:                             <ol style="list-style-type: none"> <li>A) Low gas pressure</li> <li>B) Dirty or partially clogged ODS/pilot</li> </ol> </li> <li>6. Thermocouple connection loose at control valve</li> <li>7. Thermocouple damaged</li> <li>8. Control valve damaged</li> </ol>	<ol style="list-style-type: none"> <li>1. Press in control knob fully</li> <li>2. After ODS/pilot lights, keep control knob pressed in 30 seconds</li> <li>3. Wait one minute for safety interlock system to reset. Repeat ignition operation</li> <li>4. Fully open equipment shutoff valve</li> <li>5.                             <ol style="list-style-type: none"> <li>A) Contact local natural or propane/LP gas company</li> <li>B) Clean ODS/pilot (<i>see <a href="#">Cleaning and Maintenance, Page 22</a></i>) or replace ODS/pilot assembly</li> </ol> </li> <li>6. Hand tighten until snug, then tighten 1/4 turn more</li> <li>7. Replace pilot assembly</li> <li>8. Replace control valve</li> </ol>



## TROUBLESHOOTING *Continued*

OBSERVED PROBLEM	POSSIBLE CAUSE	REMEDY
Burner does not light after ODS/pilot is lit	<ol style="list-style-type: none"> <li>1. Inlet gas pressure is too low</li> <li>2. Burner orifice(s) clogged</li>   <li>3. Thermopile leads disconnected or improperly connected (Remote-Ready Models Only)</li> <li>4. Burners will not come on in remote position (Remote-Ready Models Only)</li> </ol>	<ol style="list-style-type: none"> <li>1. Contact local natural or propane/LP gas company</li> <li>2. Clean burner(s) (<i>see <u>Cleaning and Maintenance, Page 22</u></i>) or replace burner orifice(s)</li> <li>3. Reconnect leads (<i>see <u>Wiring Diagram, Page 32</u></i>)</li> <li>4. Replace battery in transmitter and receiver</li> </ol>
Delayed ignition of one or both burners	<ol style="list-style-type: none"> <li>1. Manifold pressure is too low</li> <li>2. Burner orifice(s) clogged</li> </ol>	<ol style="list-style-type: none"> <li>1. Contact local natural or propane/LP gas company</li> <li>2. Clean burner(s) (<i>see <u>Cleaning and Maintenance, Page 22</u></i>) or replace burner orifice(s)</li> </ol>
Burner backfiring during combustion	<ol style="list-style-type: none"> <li>1. Burner orifice is clogged or damaged</li> <li>2. Damaged burner</li> <li>3. Gas regulator defective</li> </ol>	<ol style="list-style-type: none"> <li>1. Clean burner (<i>see <u>Cleaning and Maintenance, Page 22</u></i>) or replace burner orifice</li> <li>2. Replace damaged burner</li> <li>3. Replace gas regulator</li> </ol>
Slight smoke or odor during initial operation	<ol style="list-style-type: none"> <li>1. Not enough air</li> <li>2. Gas regulator defective</li> <li>3. Residues from manufacturing processes and logs curing</li> </ol>	<ol style="list-style-type: none"> <li>1. Check burner for dirt and debris. If found, clean burner (<i>see <u>Cleaning and Maintenance, Page 22</u></i>)</li> <li>2. Replace gas control</li> <li>3. Problem will stop after a few hours of operation</li> </ol>
Heater produces a whistling noise when burners are lit	<ol style="list-style-type: none"> <li>1. Turning control knob to HI position when burners are cold</li> <li>2. Air in gas line</li>   <li>3. Air passageways on heater blocked</li> <li>4. Dirty or partially clogged burner orifice(s)</li> </ol>	<ol style="list-style-type: none"> <li>1. Turn control knob to LO position and let warm up for a minute</li> <li>2. Operate burners until air is removed from line. Have gas line checked by local natural or propane/LP gas company</li> <li>3. Observe minimum installation clearances (<i>see <u>Pages 9 through 10</u></i>)</li> <li>4. Clean burners (<i>see <u>Cleaning and Maintenance, Page 22</u></i>) or replace burner orifice</li> </ol>
White powder residue forming within burner box or on adjacent walls or furniture	<ol style="list-style-type: none"> <li>1. When heated, vapors from furniture polish, wax, carpet cleaners, etc. may turn into white powder residue</li> </ol>	<ol style="list-style-type: none"> <li>1. Turn heater off when using furniture polish, wax, carpet cleaners or similar products</li> </ol>
Moisture/condensation noticed on windows	<ol style="list-style-type: none"> <li>1. Not enough combustion/ventilation air</li> </ol>	<ol style="list-style-type: none"> <li>1. Refer to <i><u>Air for Combustion and Ventilation</u></i> requirements (<b>Page 6</b>)</li> </ol>
Dark residue on logs inside of their fireplace NOTE: After removing all causes of residue deposits, completely clean fireplace and appliance off residue before reusing appliance	<ol style="list-style-type: none"> <li>1. Improper log placement</li> <li>2. Drafts or other air currents affecting flame pattern</li> <li>3. Air holes at burner inlet blocked</li> <li>4. Burner flame holes blocked</li> </ol>	<ol style="list-style-type: none"> <li>1. Properly locate logs (<i>see <u>Installing Logs, Page 14</u></i>)</li> <li>2. Eliminate source of drafts around heater</li> <li>3. Clean out air holes at burner inlet. Periodically repeat as needed</li> <li>4. Remove blockage or replace burner</li> </ol>
Heater produces a clicking/ticking noise just after burners are lit or shut off	<ol style="list-style-type: none"> <li>1. Metal expanding while heating or contracting while cooling</li> </ol>	<ol style="list-style-type: none"> <li>1. This is normal with most heaters. If noise is excessive, contact qualified service person</li> </ol>

**⚠ WARNING: If you smell gas**

- Shut off gas supply.
- Do not try to light any appliance.
- Do not touch any electrical switch; do not use any phone in your building.
- Leave the building immediately
- Immediately call your gas supplier from a neighbor's phone. Follow the gas supplier's instructions.
- If you cannot reach your gas supplier, call the fire department.

**IMPORTANT:** Operating heater where impurities in air exist may create odors. Cleaning supplies, paint, paint remover, cigarette smoke, cements and glues, new carpet or textiles, etc., create fumes. These fumes may mix with combustion air and create odors. These odors will disappear over time.

OBSERVED PROBLEM	POSSIBLE CAUSE	REMEDY
Heater produces unwanted odors	<ol style="list-style-type: none"> <li>1. Heater burning vapors from paint, hair spray, glues, cleaners, chemicals, new carpet, etc. (See <b>IMPORTANT</b> statement above)</li> <li>2. Low fuel supply (propane/LP only)</li> <li>3. Gas leak. <b>See Warning statement at top of page</b></li> </ol>	<ol style="list-style-type: none"> <li>1. Open window to ventilate room. Stop using odor causing products while heater is running</li> <li>2. Refill supply tank (propane/LP only)</li> <li>3. Locate and correct all leaks (see <i>Checking Gas Connections, Page 13</i>)</li> </ol>
Heater shuts off in use (ODS operates)	<ol style="list-style-type: none"> <li>1. Not enough fresh air is available</li> <li>2. Low line pressure</li> <li>3. ODS/pilot is partially clogged</li> </ol>	<ol style="list-style-type: none"> <li>1. Open window and/or door for ventilation</li> <li>2. Contact local natural or propane/LP gas company</li> <li>3. Clean ODS/pilot (see <i>Cleaning and Maintenance, Page 22</i>)</li> </ol>
Gas odor even when control knob is in OFF position	<ol style="list-style-type: none"> <li>1. Gas leak. <b>See Warning statement at top of page</b></li> <li>2. Control valve defective</li> </ol>	<ol style="list-style-type: none"> <li>1. Locate and correct all leaks (see <i>Checking Gas Connections, Page 13</i>)</li> <li>2. Replace control valve</li> </ol>
Gas odor during combustion	<ol style="list-style-type: none"> <li>1. Foreign matter between control valve and burner</li> <li>2. Gas leak. <b>See Warning statement at top of page</b></li> </ol>	<ol style="list-style-type: none"> <li>1. Take apart gas tubing and remove foreign matter</li> <li>2. Locate and correct all leaks (see <i>Checking Gas Connections, Page 13</i>)</li> </ol>

## PARTS

### BURNER SYSTEMS EOS18MN AND EOS18MP

CAT. NO.	MODEL
F0155	EOS18MN
F0156	EOS18MP

**⚠ WARNING:** Failure to position the parts in accordance with these diagrams or failure to use only parts specifically approved with this heater may result in property damage or personal injury.

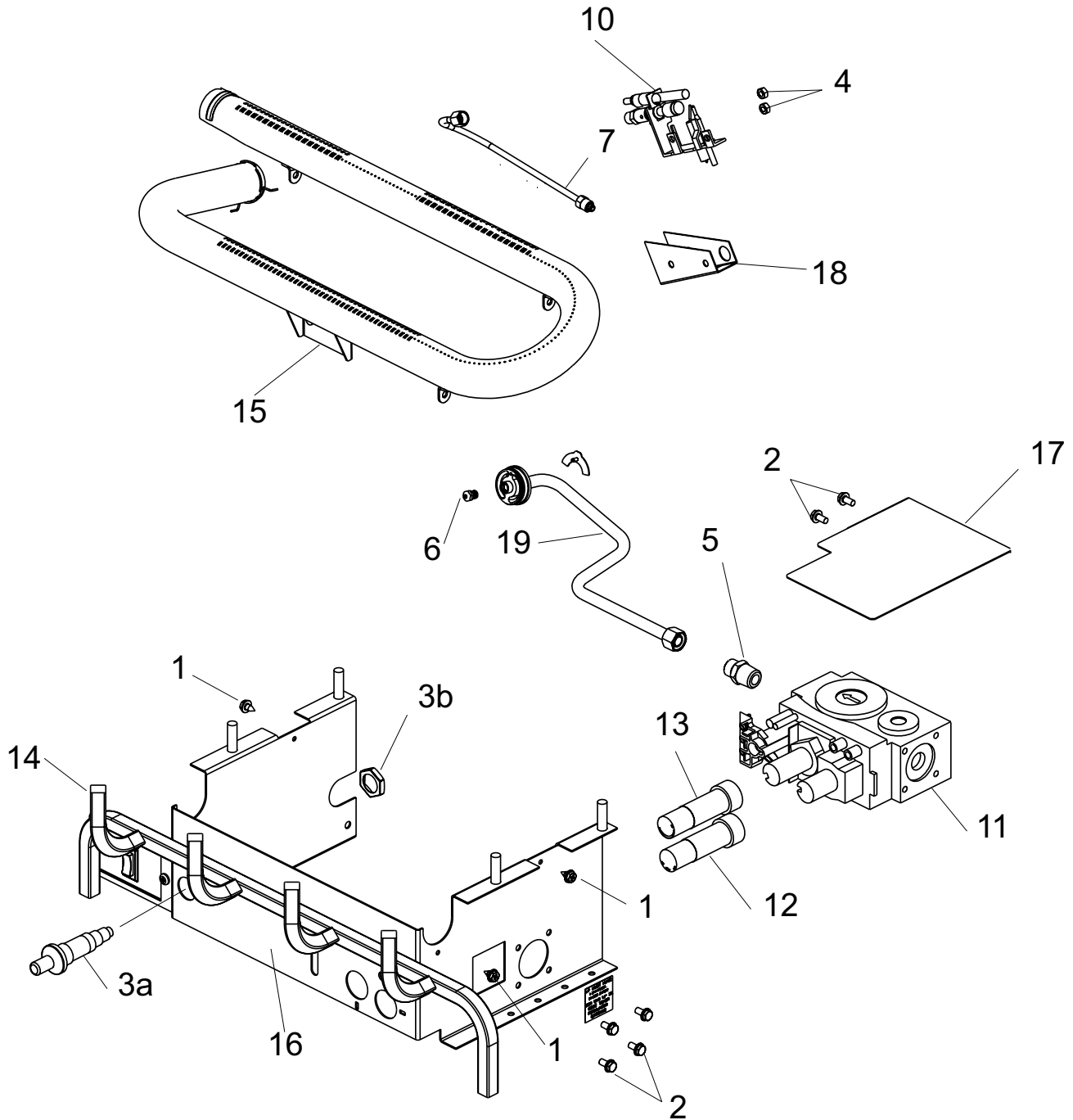

## PARTS *Continued*

This list contains replaceable parts used in your heater. When ordering parts, follow the instructions listed under *Replacement Parts* on **Page 32** of this manual.

**⚠ WARNING: Contact IHP to obtain any of these parts. Never use substitute materials not approved by Contact IHP to obtain. Use of non-approved parts can result in poor performance and safety hazards.**

KEY NO.	CAT. NO.	DESCRIPTION	EOS18MN	EOS18MP	QTY.
1	F3327	Screw, HWH AB 10-16 x .38	•	•	5
2	J1961	Screw, HX SLT WSR 10-32 x .38	•	•	6
3a	J3545	Piezo Igniter	•	•	1
3b	J3744	Palnut Fastener	•	•	1
4	J3558	Nut, ODS	•	•	2
5	J3562	Male Connector	•	•	1
6	J3618	Orifice, .111	•		1
	J3617	Orifice, .073		•	1
7	J3635	Pilot Tube	•	•	1
10	J3830	Pilot, ODS (LP)		•	1
	J6425	Pilot, ODS (NG)	•		1
11	J3836	Gas Valve (NG)	•		1
	J3837	Gas Valve (LP)		•	1
12	J3840	Knob Extension (HI/LO)	•	•	1
13	J3841	Knob Extension (ON/OFF)	•	•	1
14	**	Grate	•	•	1
15	J5537	Burner (NG)	•		1
	J5538	Burner (LP)		•	1
16	**	Log Base	•	•	1
17	J6128	Heat Shield	•	•	1
18	J5266	Pilot Shield	•		4
19	J6125	Inlet Tube - LP		•	4
	F3027	Inlet Tube - NG	•		1
<b>PARTS AVAILABLE - NOT SHOWN</b>					
	J3569	Cable Igniter	•	•	1
	J3720	Wire Harness	•	•	1
	J3658	Warning Plate	•	•	1
	J3846	Lighting Instructions Plate	•	•	1
	J3689	Hardware Kit	•	•	1
	80L42	Volcanic Stone, FDVS	•	•	1

\*\* Not a field replaceable part.

**PARTS** *Continued*

**LOG SET MODEL: CHESTNUTHILLHD18 AND CHESTNUTHILLHD24 LOGS (CHESTNUT HILL HD™)**

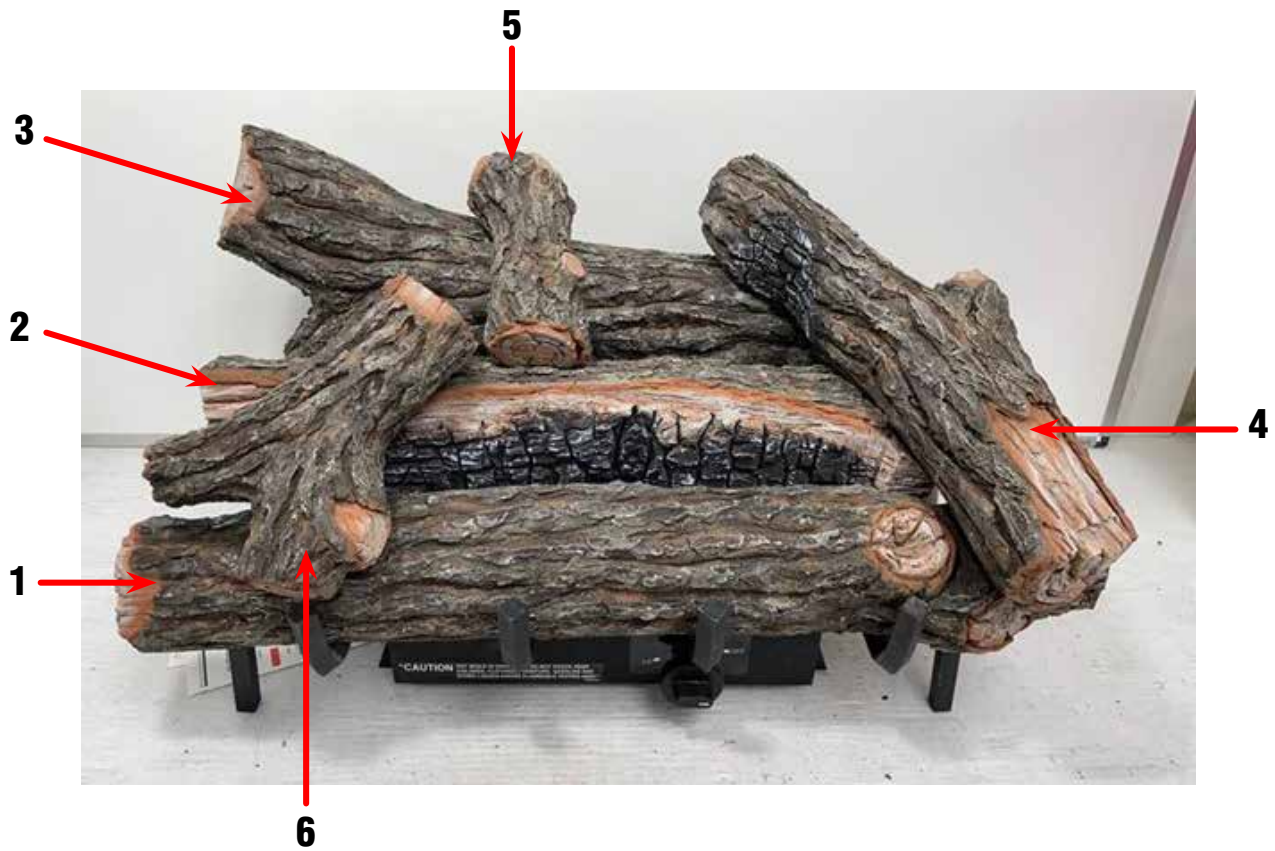

KEY NO.	CAT. NO.	DESCRIPTION			QTY.
			CHESTNUTHILLHD18	CHESTNUTHILLHD24	
1	*	18" Front Log	•		1
	*	24" Front Log		•	1
2	*	18" Middle Log	•		1
	*	24" Middle Log		•	1
3	*	18" Rear Log	•		1
	*	24" Rear Log		•	1
4	*	18" Top Right Log	•		1
	*	24" Top Right Log		•	1
5	*	18" Top Middle Log	•		1
	*	24" Top Middle Log		•	1
6	*	18" Top Left Log	•		1
	*	24" Top Left Log		•	1
7	F4651	18" Complete Log Set	•		1
	F4652	24" Complete Log Set		•	1

\*Order complete log set

**⚠ WARNING:** When ordering replacement logs or log sets, only logs from the same log set model and size may be used. Mixing of logs from different model log sets or sizes is strictly prohibited and may result in improper operation, property damage, and/or personal injury.

**PARTS** *Continued*

**LOG SET MODEL: CHESTNUT18 AND CHESTNUT24 LOGS (CHESTNUT HILL™)**

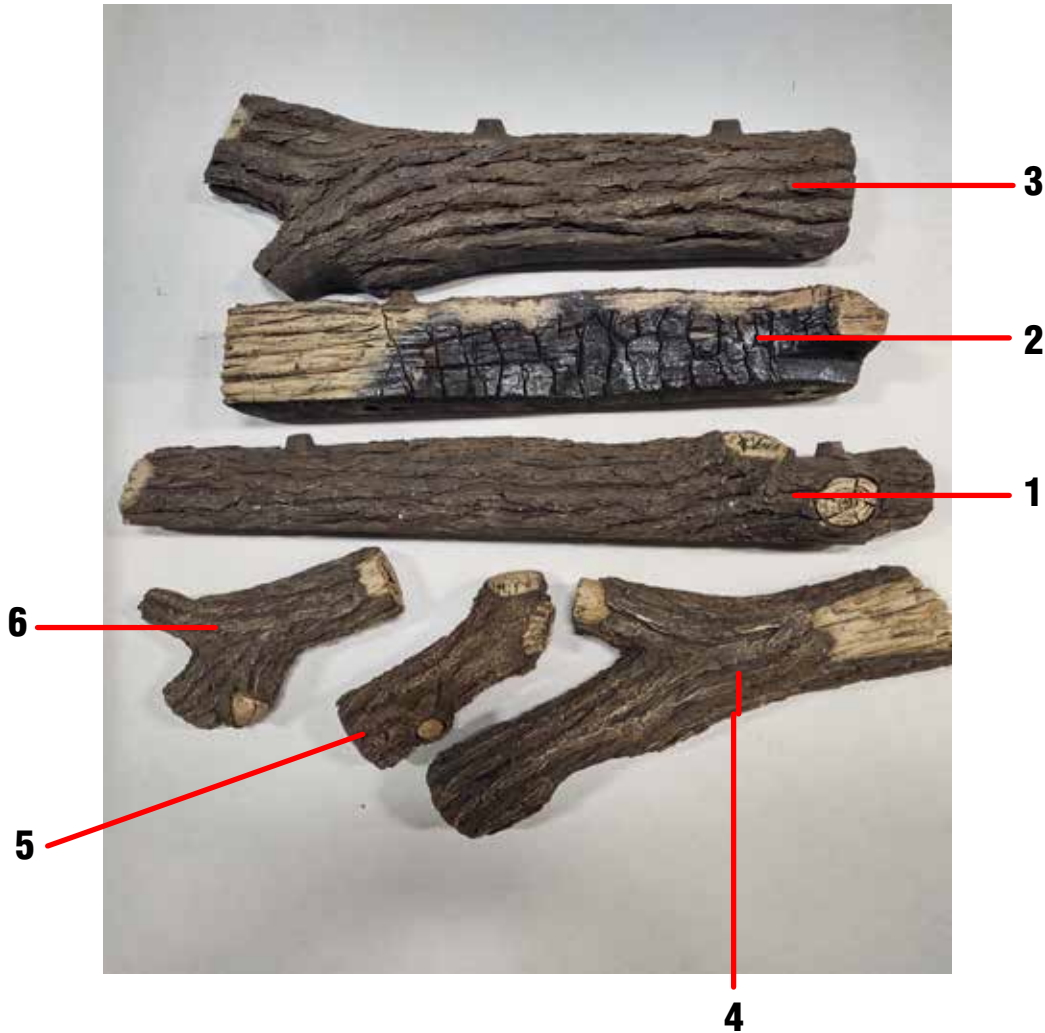

KEY NO.	CAT. NO.	DESCRIPTION			QTY.
			CHESTNUT18	CHESTNUT24	
1	*	18" Front Log	•		1
	*	24" Front Log		•	1
2	*	18" Middle Log	•		1
	*	24" Middle Log		•	1
3	*	18" Rear Log	•		1
	*	24" Rear Log		•	1
4	*	18" Top Right Log	•		1
	*	24" Top Right Log		•	1
5	*	18" Top Middle Log	•		1
	*	24" Top Middle Log		•	1
6	*	18" Top Left Log	•		1
	*	24" Top Left Log		•	1
7	F0157	18" Complete Log Set	•		1
	F0158	24" Complete Log Set		•	1

\*Order complete log set

**⚠ WARNING:** When ordering replacement logs or log sets, only logs from the same log set model and size may be used. Mixing of logs from different model log sets or sizes is strictly prohibited and may result in improper operation, property damage, and/or personal injury.

**PARTS *Continued***

**LOG SET MODEL: BLONDEOAK18 AND BLONDEOAK24 LOGS**

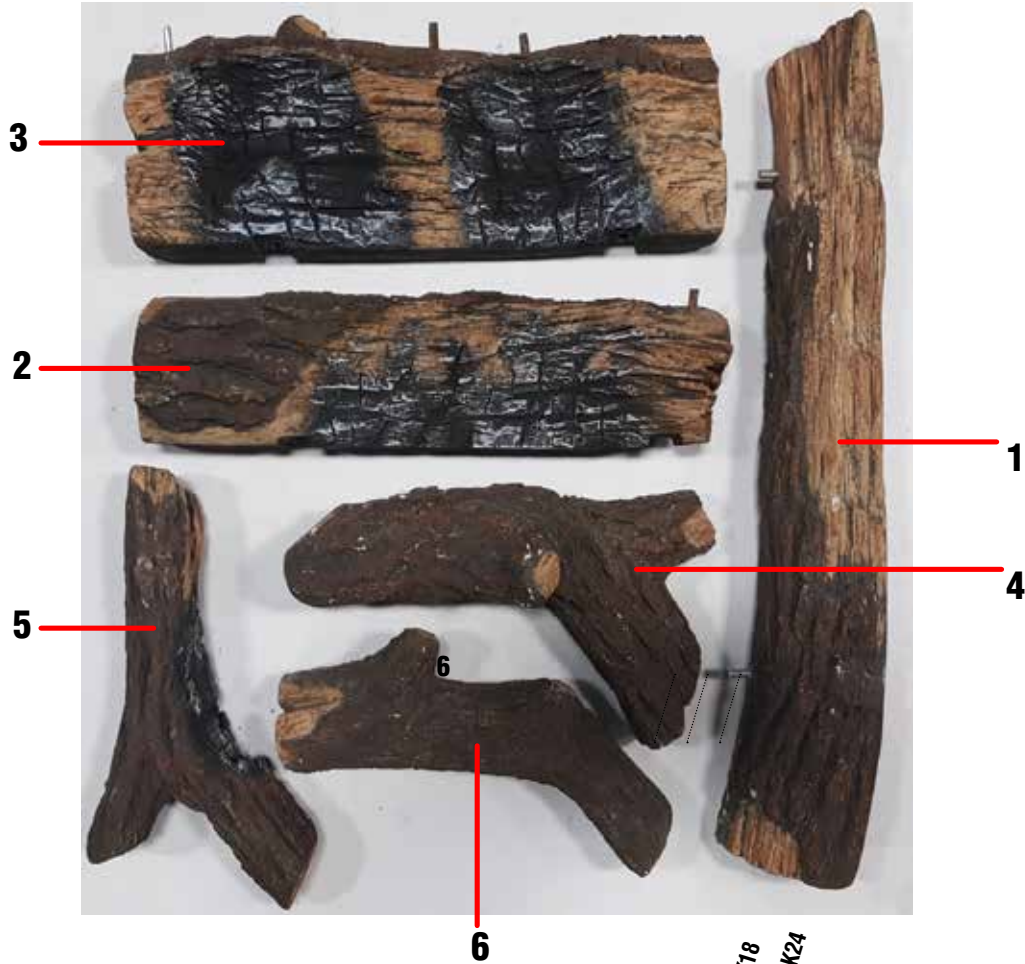

KEY NO.	CAT. NO.	DESCRIPTION	BLONDEOAK18		BLONDEOAK24		QTY.
1	*	18" Front Log	•				1
	*	24" Front Log			•		1
2	*	18" Middle Log	•				1
	*	24" Middle Log			•		1
3	*	18" Rear Log	•				1
	*	24" Rear Log			•		1
4	*	18" Top Right Log	•				1
	*	24" Top Right Log			•		1
5	*	18" Top Middle Log	•				1
	*	24" Top Middle Log			•		1
6	*	18" Top Left Log	•				1
	*	24" Top Left Log			•		1
7	F4637	18" Complete Log Set	•				1
	F4638	24" Complete Log Set			•		1

\*Order complete log set

**⚠ WARNING:** When ordering replacement logs or log sets, only logs from the same log set model and size may be used. Mixing of logs from different model log sets or sizes is strictly prohibited and may result in improper operation, property damage, and/or personal injury.

## WIRING DIAGRAM

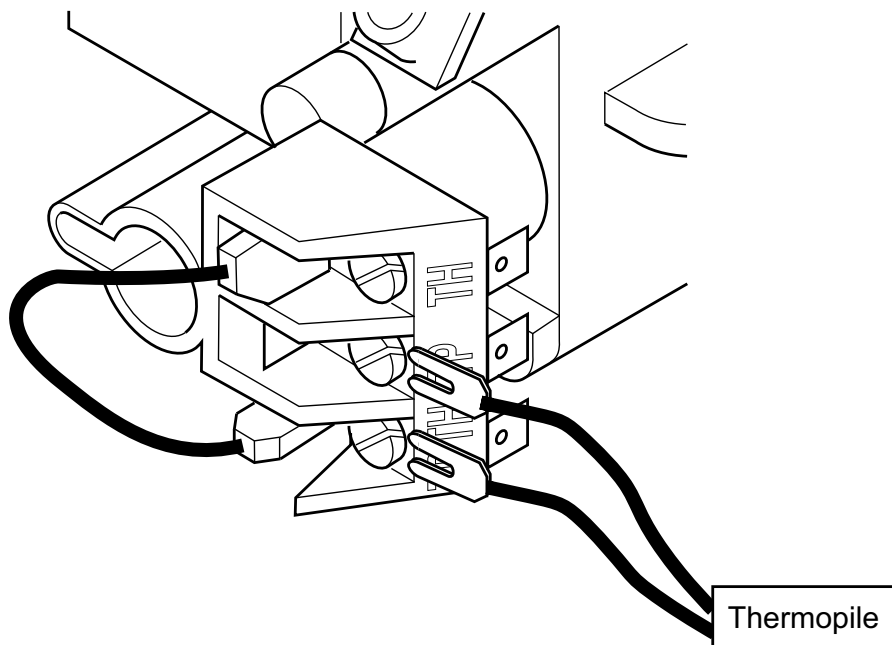

**⚠ CAUTION: Label all wires prior to disconnection when servicing controls. Wiring errors can cause improper and dangerous operation. Verify proper operation after servicing.**

## SPECIFICATIONS

### EOS18MN

- Rating: 25,000/36,000 Btu/hr
- Gas Type: Propane/LP
- Ignition: Piezo
- Manifold Pressure: 8.0" W.C.
- Inlet Supply Pressure (inches of water):  
Maximum - 14" W.C., Minimum - 11" W.C.

### EOS18MP

- Rating: 25,000/36,000 Btu/hr
- Gas Type: Natural
- Ignition: Piezo
- Manifold Pressure: 3.5" W.C.
- Inlet Supply Pressure (inches of water):  
Maximum - 10.5" W.C., Minimum - 5" W.C.

## REPLACEMENT PARTS

See **Pages 28-33** for a complete replacement parts list. Use only parts supplied from the manufacturer.

Normally, all parts should be ordered through your IHP distributor or dealer. Parts will be shipped at prevailing prices at time of order.

**NEVER USE SUBSTITUTE MATERIALS. USE OF NON-APPROVED PARTS CAN RESULT IN POOR PERFORMANCE AND SAFETY HAZARDS.**

## SERVICE HINTS

### When Gas Pressure Is Too Low

- pilot will not stay lit
- burners will have delayed ignition
- appliance will not produce specified heat
- propane/LP gas supply may be low

You may feel your gas pressure is too low. If so, contact your local propane/LP or natural gas supplier.

**When ordering repair parts, always give the following information:**

1. The model number of the appliance.
2. The serial number of the appliance.
3. The part number.
4. The description of the part.
5. The quantity required.
6. The installation date of the appliance.

If you encounter any problems or have any questions concerning the installation or application of this appliance, please contact your dealer.

## TECHNICAL SERVICE







You may have further questions about installation, operation, or troubleshooting. Please contact your IHP dealer for any questions or concerns. When contacting your dealer please have your model and serial numbers of your appliance ready. You can also visit our web site at [Astria.us.com](http://Astria.us.com).

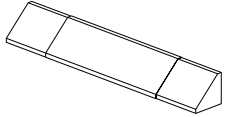

## ACCESSORIES

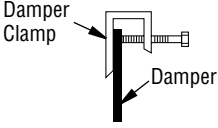
Purchase these appliance accessories from your local dealer. If they can not supply these accessories, contact IHP at [Astria.us.com](http://Astria.us.com) for referral information. You can also write to the address listed on the back page of this manual.

**Only kits supplied by IHP shall be used in the installation of this appliance. Use of non-approved accessory/part kit(s) can result in poor performance and safety hazards.**

CAT NO.	MODEL	DESCRIPTION	
<b>FIREPLACE HOOD, BLACK</b>			
For all models. Helps deflect heat away from mantel or wall above fireplace. Fits openings 28" to 48" wide.			
F1764	GA6050	Hood, Adjustable Flat Black	
<b>DECORATIVE ASH BED / CONTROL COVER KIT</b>			
F1759	CDABKA-6	KIT, DECORATIVE ASH BED 6PK	
F0246	CDABKA	Decorative Ash Bed / Control Cover Kit	
<b>DAMPER CLAMP (Required in vented applications)</b>			
For all models. Permanently opens chimney flue damper for vented operation. This is included with all models.			
F1760	GA6080	30 Degree Offset and Return	
<b>VOLCANIC STONE</b>			
For all models. Order when additional volcanic stone is desired.			
80L42	FDVS	Volcanic Stone	
<b>FLOOR MEDIA KIT</b>			
For all models. Includes volcanic stone, burner embers, and burner cinders			
F1762	FM100	Kit Floor Media	
<b>LOG SCRAPS</b>			
F0250	VTA-LS5-1	Log Scraps / Floor Media Kit-1	
F0251	VTA-LS5-2	Log Scraps / Floor Media Kit-2	

## ACCESSORIES *Continued*

CAT NO.	MODEL	DESCRIPTION	
<p style="text-align: center;"><b>RECEIVER AND HAND-HELD THERMOSTAT REMOTE CONTROL KIT</b></p> <p>For all models. Allows the fireplace to be operated in a manually or thermostatically controlled mode. You can turn the fireplace on and off without ever leaving the comfort of your easy chair.</p>			
F1078	TRC	Kit, Thermostat Remote Control	
<p style="text-align: center;"><b>ON/OFF REMOTE AND RECEIVER WITH WHITE WALL PLATE</b></p> <p>For all Remote-Ready Models. Allows the fireplace to be turned on and off by using a hand-held remote control.</p>			
F2236	RCKIT 4001	On/Off Remote and receiver w white cover	
<p style="text-align: center;"><b>RECEIVER AND REMOTE CONTROL KIT</b></p> <p>For all Remote-Ready Models. Allows the burner system to be operated in a manually or thermostatically controlled mode. Remote is programmable for your convenience and has a large bright LCD Touch Screen for easy use.</p>			
F1079	TSRC	Kit, Touch Screen Remote Contr	
<p style="text-align: center;"><b>WALL-MOUNT THERMOSTAT SWITCH</b></p> <p>For all models. The desired comfort setting can be selected on the wall thermostat and the log heater will automatically cycle from pilot to the heat setting selected. Includes thermostat assembly, 25' of wire and two mounting screws.</p>			
F2040	GWMT1	Kit, Thermostat Wall Mount	
<p style="text-align: center;"><b>WALL-MOUNT ON/OFF SWITCH</b></p> <p>For all models. Allows the gas log heater to be turned on and off with a wall switch.</p>			
F0245	GWMS2	On/Off Wall Switch Kit	
<p style="text-align: center;"><b>GAS APPLIANCE INSTALLATION KIT</b></p>			
F0249	CIKA	Gas Appliance Installation Kit	

# Innovative Hearth Products Astria® Brand Gas Log Set & Outdoor Gas Fire Pit Limited Three Year Warranty

## THE WARRANTY

Innovative Hearth Products Limited Three Year Warranty ("IHP") warrants your Astria® brand Gas Log Set or Outdoor Gas Fire Pit ("Product") to be free from defects in materials and workmanship at the time of manufacture. The logs and grate carry the Limited Three Year Warranty. After installation, if covered components manufactured by IHP are found to be defective in materials or workmanship during the Limited Three Year Warranty period and while the Product remains at the site of the original installation, IHP will, at its option, repair or replace the covered components. If repair or replacement is not commercially practical, IHP will, at its option, refund the purchase price or wholesale price of the IHP product, whichever is applicable. IHP will also pay IHP prevailing labor rates, as determined in its sole discretion, incurred in repairing or replacing such components. THERE ARE EXCLUSIONS AND LIMITATIONS to this Limited Three Year Warranty as described herein.

## COVERAGE COMMENCEMENT DATE

Warranty coverage begins on the date of purchase. In the case of new home construction, warranty coverage begins on the date of first occupancy of the dwelling or six months after the sale of the Product by an independent IHP dealer, whichever occurs earlier. The warranty shall commence no later than 24 months following the date of product shipment from IHP, regardless of the installation or occupancy date.

## EXCLUSIONS AND LIMITATIONS

This Limited Three Year Warranty applies only if the Product is installed in the United States or Canada and only if operated and maintained in accordance with the printed instructions accompanying the Product and in compliance with all applicable installation and building codes and good trade practices.

This warranty is non-transferable and extends to the original owner only. The Product must be purchased through a listed supplier of IHP and proof of purchase must be provided. The following do not carry the Limited Three Year Warranty but are warranted as follows:

**Gas components** – Repair or replacement for one year from the date of installation.

**Remote control** – Repair or replacement for one year from the date of installation.

**Labor coverage** – Prevailing IHP labor rates apply for the warranty period of the component.

**Parts not otherwise listed carry a 90 day warranty from the date of installation.**

**Whenever practicable, IHP will provide replacement parts, if available, for a period of 10 years from the last date of manufacture of the product.**

IHP will not be responsible for: (a) damages caused by normal wear and tear, accident, riot, fire, flood or acts of God; (b) damages caused by abuse, negligence, misuse, or unauthorized alteration or repair of the Product affecting its stability or performance (The Product must be subjected to normal use. The Product is designed to burn either natural or propane gas only. Burning conventional fuels such as wood, coal or any other solid fuel will cause damage to the Product, will produce excessive temperatures and could result in a fire hazard.); (c) damages caused by failing to provide proper maintenance and service in accordance with the instructions provided with the Product; (d) damages, repairs or inefficiency resulting from faulty installation or application of the Product.

This Limited Three Year Warranty covers only parts and labor as provided herein. In no case shall IHP be responsible for materials, components or construction which are not manufactured or supplied by IHP or for the labor necessary to install, repair or remove such materials, components or construction. Additional utility bills incurred due to any malfunction or defect in equipment are not covered by this warranty. All replacement or repair components will be shipped F.O.B. from the nearest stocking IHP factory.

## LIMITATION ON LIABILITY

It is expressly agreed and understood that IHP's sole obligation and the purchaser's exclusive remedy under this warranty, under any other warranty, expressed or implied, or in contract, tort or otherwise, shall be limited to replacement, repair, or refund, as specified herein.

In no event shall IHP be liable for any incidental or consequential damages caused by defects in the Product, whether such damage occurs or is discovered before or after replacement or repair, and whether such damage is caused by IHP's negligence. IHP has not made and does not make any representation or warranty of fitness for a particular use or purpose, and there is no implied condition of fitness for a particular use or purpose.

IHP makes no expressed warranties except as stated in this Limited Three Year Warranty. The duration of any implied warranty is limited to the duration of this expressed warranty.

No one is authorized to change this Limited Three Year Warranty or to create for IHP any other obligation or liability in connection with the Product. Some states and provinces do not allow the exclusion or limitation of incidental or consequential damages, so the above limitations or exclusions may not apply to you. The provisions of this Limited Three Year Warranty are in addition to and not a modification of or subtraction from any statutory warranties and other rights and remedies provided by law.

## INVESTIGATION OF CLAIMS AGAINST WARRANTY

IHP reserves the right to investigate any and all claims against this Limited Three Year Warranty and to decide, in its sole discretion, upon the method of settlement.

To receive the benefits and advantages described in this Limited Three Year Warranty, the appliance must be installed and repaired by a licensed contractor approved by IHP.

Contact IHP at the address provided herein to obtain a listing of approved dealers/distributors. **IHP shall in no event be responsible for any warranty work done by a contractor that is not approved without first obtaining IHP's prior written consent.**

## HOW TO REGISTER A CLAIM AGAINST WARRANTY

In order for any claim under this warranty to be valid, you must contact the IHP dealer/distributor from which you purchased the product. If you cannot locate the dealer/distributor, then you must notify IHP in writing. IHP must be notified of the claimed defect in writing within 90 days of the date of failure. Notices should be directed to the IHP Warranty Department at 1769 East Lawrence Street; Russellville, AL 35654 or visit our website at [WWW.ASTRIA.US.COM](http://WWW.ASTRIA.US.COM).

**Astria.us.com**

Record the following important information about your appliance:

Appliance model number	
Appliance serial number	
Date appliance was Installed	
Type of gas appliance uses	
Dealer name	

---

Innovative Hearth Products (IHP) reserves the right to make changes at any time, without notice, in design, materials, specifications, prices and also to discontinue colors, styles and products. Consult your local distributor for fireplace code information.

