



STANDARD FEATURES

- ◆ Available in 36", 42" and 50" models

- ◆ Massive smoke dome with no visible smoke shelf for reliable operation

- ◆ Fully insulated firebox for increased performance in colder climates

- ◆ Mosaic Masonry Firebrick or Estate Refractory Panels available in a variety of patterns and colors with integrated ash lip (one required)

- ◆ Heavy duty steel grate with rugged forged andirons

- ◆ Easy access damper control

- ◆ Includes mesh fire screens

- ◆ Optional glass doors available in black trim finish for improved safety

- ◆ Optional gas log sets deliver the charm of a wood fire with the convenience of gas

- ◆ Dual (left hand/right hand) outside air kits available for maximum performance

- ◆ Durable textured powder coat finish

- ◆ Uses IHP 12DM or 12HT (required for Canada) chimney system

- ◆ 20 Year Limited Warranty

MOSAIC MASONRY FIREBRICK LINERS



ESTATE PANEL REFRACTORY LINERS



Gas Log Sets



Glass Doors



FLAT WALL FRAMING SPECIFICATIONS

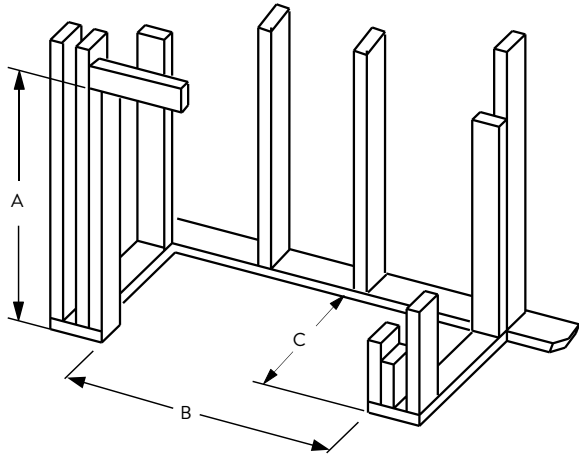

	GEORGIAN 36	GEORGIAN 42	GEORGIAN 50
A	67-1/8"	67-1/8"	67-1/8"
B	45-1/4"	51-1/4"	59-1/4"
C	28-1/4"	30-1/8"	30-1/8"

CORNER FRAMING SPECIFICATIONS

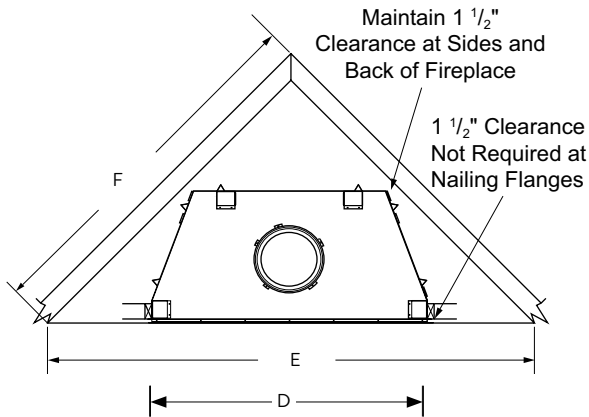

	GEORGIAN 36	GEORGIAN 42	GEORGIAN 50
D	45-1/4"	51-1/4"	59-1/4"
E	86-1/2"	92"	100"
F	61"	65"	71"

APPLIANCE SPECIFICATIONS

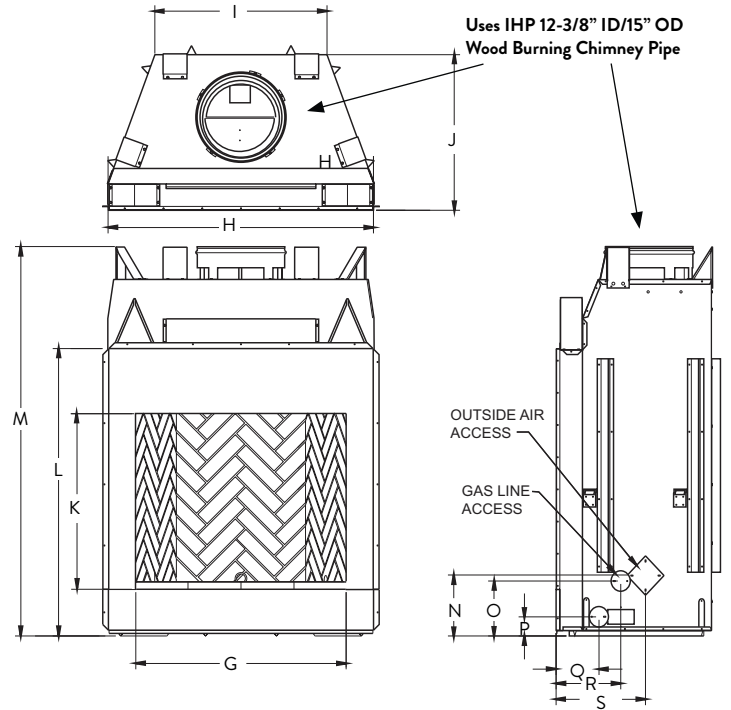

	GEORGIAN 36	GEORGIAN 42	GEORGIAN 50
G	36"	42"	50"
H	45-1/8"	51-1/8"	59"
I	29"	30-1/2"	38-1/2"
J	26-5/8"	29"	28-1/2"
K	30"	30"	30"
L	49"	49"	49"
M	67"	67"	67"
N	10-1/2"	10-1/2"	10-1/2"
O	9-1/2"	9-1/2"	9-1/2"
P	3-1/2"	3-1/2"	3-1/2"
Q	7-1/4"	8-1/2"	8-1/2"
R	11"	13"	13"
S	15-1/4"	17"	17"

IMPORTANT NOTES:

As with any fireplace, this appliance is extremely hot during operation. Read and understand all operating instructions before using this appliance. For further information, consult your dealer.

Local conditions, such as elevation, wind, vent configuration and choice of fuel will affect overall appearance of the fire and heating performance. Performance can also vary with home design and insulation, climate, condition and type of fuel used, appliance location, burn rate, accessories chosen, chimney installation and how the appliance is operated.

DIAGRAMS, ILLUSTRATIONS AND PHOTOGRAPHS ARE NOT TO SCALE—CONSULT INSTALLATION INSTRUCTIONS. PRODUCT DESIGNS, MATERIALS, DIMENSIONS, SPECIFICATIONS, COLORS AND PRICES ARE SUBJECT TO CHANGE OR DISCONTINUANCE WITHOUT NOTICE.

astria
FIREPLACES®

© 2022 Innovative Hearth Products
785772M 10/22

Visit us online
Astria.us.com

PFS
C US
Report #F09-095

