



INSTALLATION INSTRUCTIONS FOR PLACEMENT OF SOUTHERNCOMFORT24A/B, SOUTHERNCOMFORT30A/B, AND SOUTHERNCOMFORT36A/B, LMF24-MS, LMF30-MS, LMF36-MS, LMF24GTA/B, LMF30GTA/B, AND LMF36GTA/B LOG SETS.

THESE LOG PLACEMENT INSTRUCTIONS ARE A SUPPLEMENT TO THE LOG BURNER INSTRUCTIONS. LOG BURNER INSTRUCTIONS MUST BE READ AND FOLLOWED TO THEIR ENTIRETY TO ASSURE SAFE AND PROPER INSTALLATION AND OPERATION. THE LOG BURNER INSTRUCTIONS ARE INCLUDED SEPARATELY INSIDE THE CARTONED LOG BURNER ASSEMBLY. ADDITIONAL COPIES OF BOTH THESE INSTRUCTIONS AND THE LOG BURNER INSTRUCTIONS ARE AVAILABLE AT www.ihp.us.com.

This log set shall only be used with the burners listed below:

MAGNIFLAME24EN	MAGNIFLAME24EP	MAGNIFLAME24MN	MAGNIFLAME24MP
MAGNIFLAME24VN	MAGNIFLAME24VP	MAGNIFLAME30EN	MAGNIFLAME30EP
MAGNIFLAME30MN	MAGNIFLAME30MP	MAGNIFLAME30VN	MAGNIFLAME30VP
MAGNIFLAMEOD24NE	MAGNIFLAMEOD24PE	MAGNIFLAMEOD24NM	MAGNIFLAMEOD24PM
MAGNIFLAMEOD30NE	MAGNIFLAMEOD30PE	MAGNIFLAMEOD30NM	MAGNIFLAMEOD30PM
MNF24ONE	MNF24OPE	MNF30ONE	MNF30OPE
MNF24INE	MNF24IPE	MNF30INE	MNF30IPE
MNF24INM	MNF30INM	MNF24IPM	MNF30IPM
MNF24ONM	MNF30ONM	MNF24OPM	MNF30OPM
MF42INE	MF42IPE	MF48INE	MF48IPE
MF42ONR	MF42OPR	MF48ONR	MF48OPR
MF42ONE	MF42OPE	MF48ONE	MF48OPE
MNF24INV	MNF24IPV	MNF30INV	MNF30IPV
MFBOD24NM	MFBOD24PM	MFBOD30NM	MFBOD30PM
VFGT24NE	VFGT24PE	VFGT30NE	VFGT30PE
VFGT36NE	VFGT36PE	VFGT24NV	VFGT24PV
VFGT30NV	VFGT30PV	VFGT36NV	VFGT36PV
VFGT24NR	VFGT24PR	VFGT30NR	VFGT30PR
VFGT36NR	VFGT36PR	VTDGT24NE	VTDGT24PE
VTDGT30NE	VTDGT30PE	VTDGT36NE	VTDGT36PE
VTDGT24NR	VTDGT24PR	VTDGT30NR	VTDGT30PR
VTDGT36NR	VTDGT36PR		

INSTALLATION OF LOGS ON ANY OTHER BURNER IS STRICTLY PROHIBITED.

If your gas log burner is not listed above, please refer to your owners manual or contact IHP Tech Support/Customer Service for further assistance.

GENERAL INFORMATION

**THE FIREPLACE MUST BE OFF AND COLD BEFORE BEGINNING.
READ ALL OF THE STEPS BEFORE STARTING THE INSTALLATION.**

PACKAGING LIST

1 ea. Complete Log Set
1 ea. Installation Instructions

TOOLS/SUPPLIES NEEDED

Safety Glasses
Protective Work Gloves
Heat Resistant Gloves

Installation and service must be performed by a qualified installer, service agency or the gas supplier. Any safety screen, guard, or barrier removed for servicing an appliance must be replaced prior to operating the heater. The fireplace screen or guard designed for this unvented appliance must be installed prior to operation.

IMPORTANT: Read the owner's manual carefully and completely before trying to assemble, operate or service this fireplace. Improper use of this fireplace can cause serious injury or death from burns, fire, explosion, electrical shock and carbon monoxide poisoning.

INSTALLER:

Leave instructions with the appliance.

CONSUMER:

Retain instructions for future reference.

This is a complete Log Set and shall not be used otherwise. This log set shall not be used for replacement of single logs.

It is very important to install these logs exactly as instructed. DO NOT MODIFY LOGS.

Failure to position the parts in accordance with these instructions or failure to use only parts specifically approved with this appliance may result in property damage or personal injury.

CAUTION: Burn hazard! Logs will remain hot after use. If you need to reposition any log to maintain the proper layout, use heat resistant gloves or allow logs adequate time to cool before handling.

1. Remove the entire Log Set provided and check for damage. If damaged, STOP!!! Contact dealer or IHP.
2. If you currently have a log set installed: Remove the entire Log Set that is currently installed on your Gas Log Burner and discard entire set.
3. Follow the steps found beginning on this page for installation of your new complete Log Set.

1. The right front log has a rectangular shape on the bottom that fits against the lip on the black metal base, the square grate, and the round tube burner. Slide the right front log in place. For reference, see *Figures 1, 1A, and 1B.*

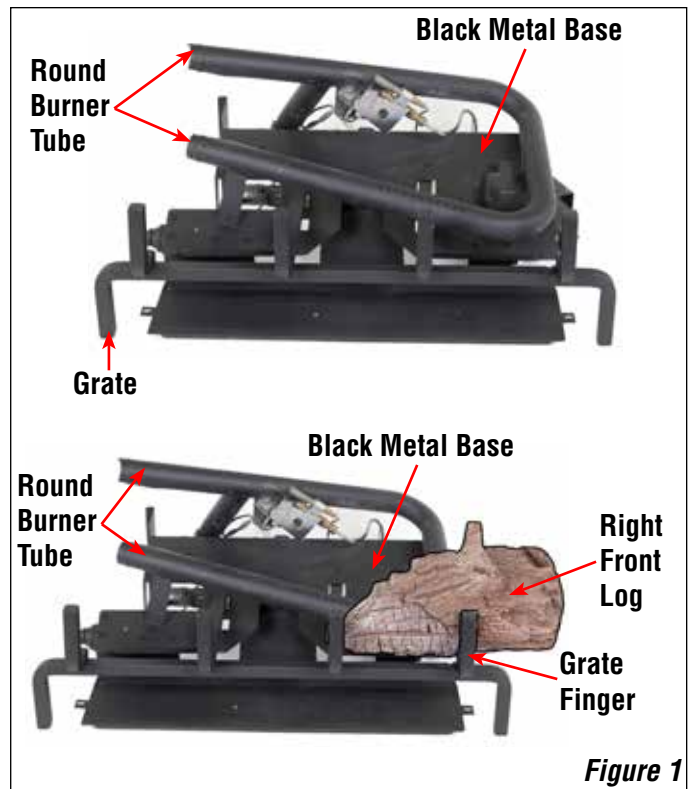

Figure 1



Figure 1A - Installing Right Front Log, Top View

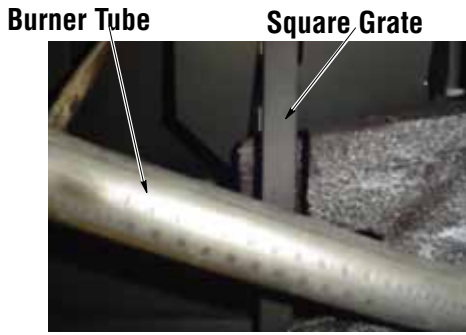

Figure 1B - Installing Right Front Log, Top View

2. *Figure 2A* shows how the back left log must fit against the end of the burner. *Figure 2B* shows how the notch in the back left log fits against the vertical portion of the burner tube. Place this log on the base assembly by inserting from the left side as shown in *Figure 2*. You will need to twist the log slightly to get it to fit against the round burner tube properly. It will rest even with the back edge of the pan.

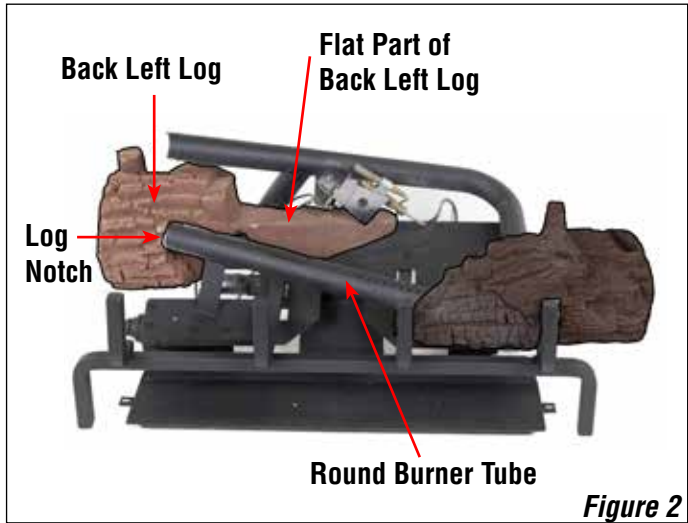

Figure 2



Figure 2A - Installing Back Left Log



Vertical Portion of Burner Tube
Figure 2B - Installing Back Left Log Rear View

3. The front left log has a rectangular stand off on the bottom that fits against the lip of the black metal base as shown in *Figure 3A*. The bottom of the front left log has a slot that fits over the second bar on the grate as shown in *Figure 3B*. Place the front left log on the base assembly as shown in *Figures 3, 3A and 3B*.

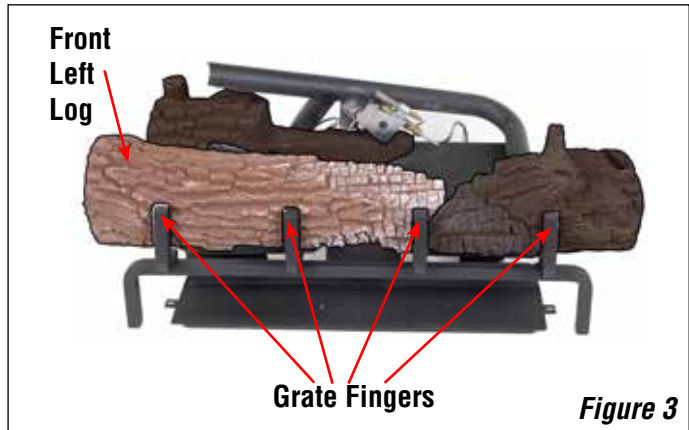

Figure 3



Figure 3A - Installing Front Left Log Side View

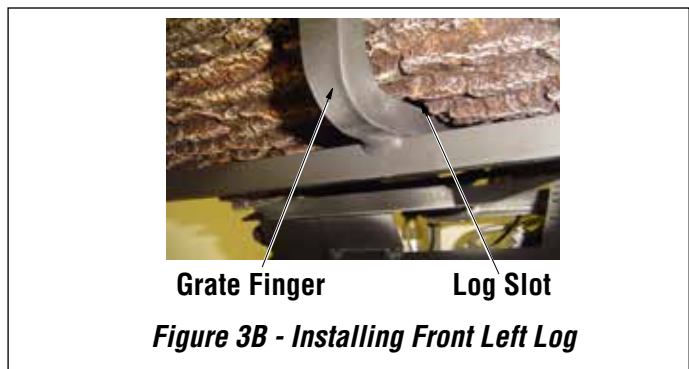
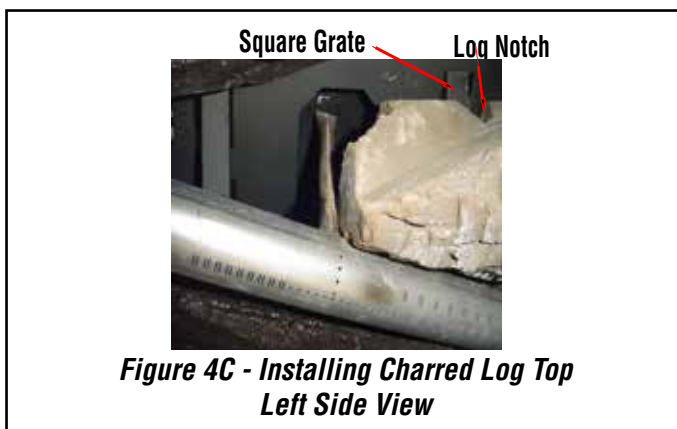
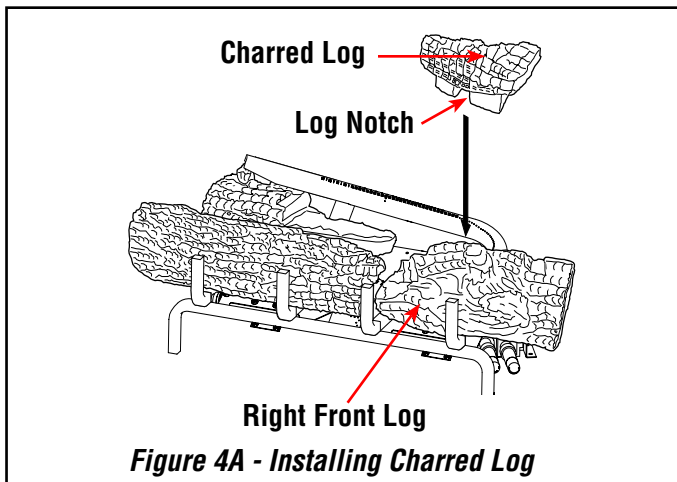
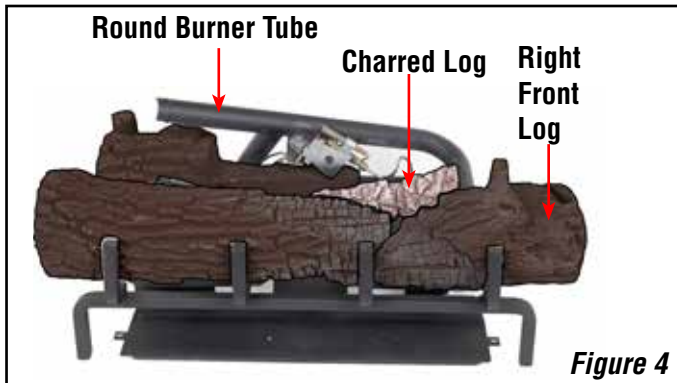
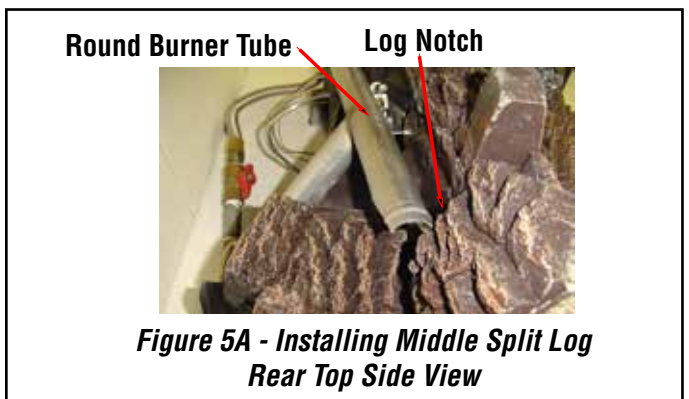
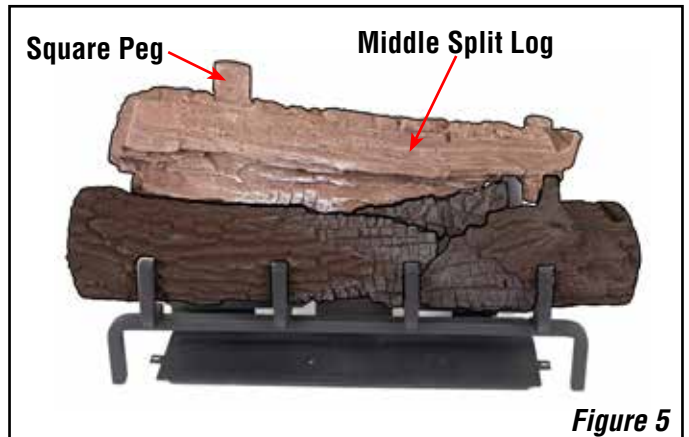

Figure 3B - Installing Front Left Log

4. The charred log has a slot in the bottom that fits over the square grate and rests against the round burner tube as shown in Figure 4A. Place the charred log on the base as shown in Figures 4, 4A, 4B and 4C.



5. The split side of the middle split log faces forward. The middle split log has a notch that fits around the round burner tube on the right side. The left side of the burner tube fits into the notch on the back side of the middle split log. The log is placed properly when it sits parallel to the tube burner and the square peg is pointing up. See Figures 5 and 5A for reference.



6. The bottom of the right split crossover log has a rectangular stand off that fits in the slots on the right side of the front right log. See Figure 6 for reference.

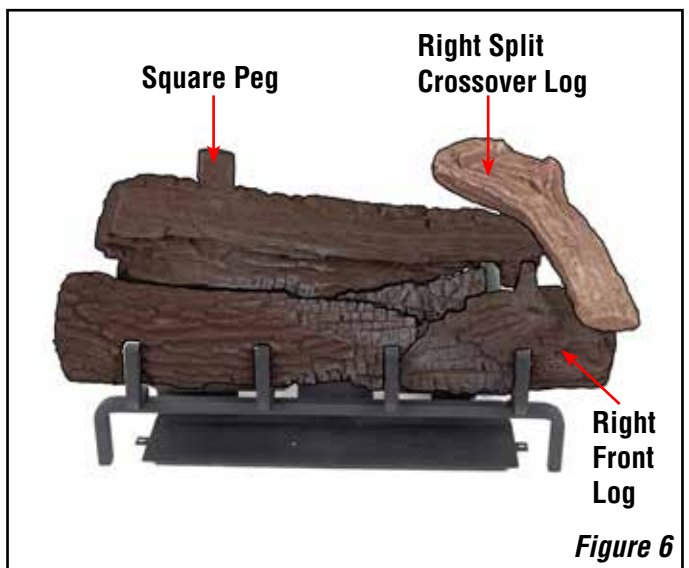

7. The left end of the front top log has a square hole that fits over a square peg that is on the top of the middle split log. The right end of the front top log rests behind the knot on the top of the right split crossover log. See *Figures 7 and 7A* for reference.

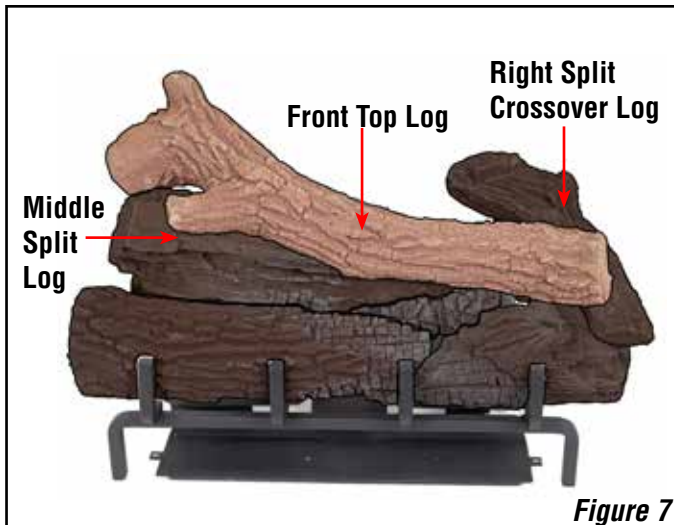

Figure 7

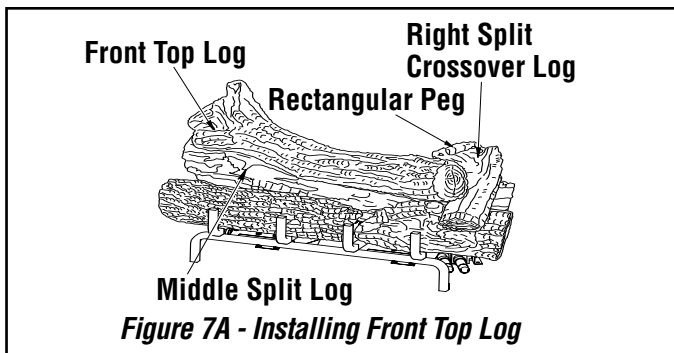

Figure 7A - Installing Front Top Log

8. The left end of the back top log has a round hole that fits over the round peg that is on the top of the back left log. The right end of the back top log has a rectangular hole that fits over the rectangular peg on the top of the right split crossover log. See *Figures 8 and 8A* for reference.

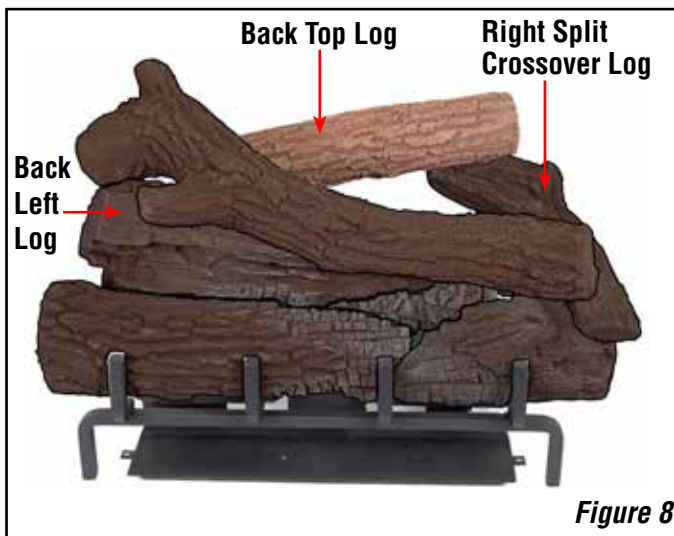

Figure 8



Figure 8A - Installing Back Top Log Top View

After setting the logs into position as described above, ensure each is properly and firmly seated. The vent-free gas log set will not function as intended if the logs are not correctly positioned. When placed properly, the flames will not strike any portion of the logs. Periodically check the positioning of all logs to ensure proper log placement and stability. If any flame is striking the logs, recheck log placement. Adjust to conform with instructions. There should be no flame impingement on the logs.

LOG INSTALLATION IS NOW COMPLETE



EMBER PLACEMENT

⚠ WARNING: Do not use any other ember material not supplied with this unit.

⚠ WARNING: Do not operate unit without ember material correctly in place as shown in *Figures 9 and 10*. Do NOT place ember material anywhere else on the unit. Use only ember material supplied with unit. Excessive or incorrectly placed ember material may produce carbon monoxide or soot. If replacement embers are needed, the replacement embers must be purchased from IHP. See *Parts Section in Owners Manual* for part numbers.

⚠ WARNING: ALL PREVIOUSLY APPLIED LOOSE MATERIAL MUST BE REMOVED PRIOR TO REAPPLICATION.

1. Two ember materials are supplied with this log set. Platinum Bright Embers give a bright glow appearing as hot coals. Should embers need replacing, see *Parts Section in Owners Manual*.

Platinum Bright Ember placement. Add embers to front, flat burner. Gently remove embers from bag. Separate pieces of ember material and place on surface of flat burner just behind horizontal ports as shown in **Figure 9**.

Glowing Embers placement. Place Glowing Embers material on front flat burner in areas away from ports as shown in **Figure 10**.

2. Add volcanic stone and small decorative logs around base of heater if desired. **DO NOT place rock or additional logs on front burner or on logs.** Placing any material on unit other than ember material on front burner may result in production of carbon monoxide or soot.

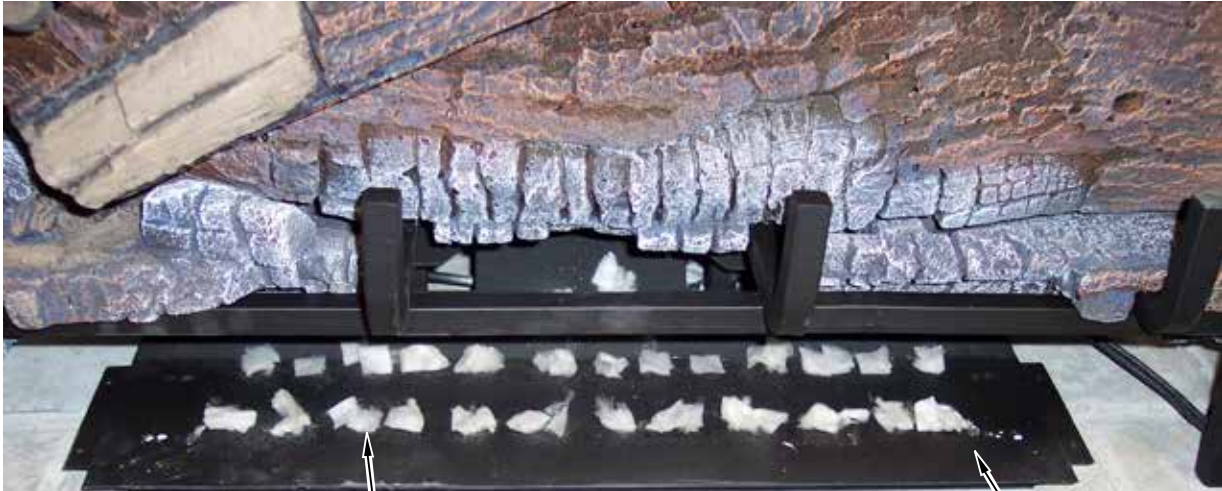

Ember Material

Figure 9 Platinum Bright Embers

Flat Front Burner



Glowing Embers (rockwool)

Figure 10 Placement of Glowing Embers (shown with Platinum Bright Embers)

Innovative Hearth Products (IHP) reserves the right to make changes at any time, without notice, in design, materials, specifications, and prices, and also to discontinue colors, styles, and products. Consult your local distributor for fireplace code information.

Printed in U.S.A. © 2021 Innovative Hearth Products
P/N 901185-00 Rev. NC 09/2021

NOTE: DIAGRAMS & ILLUSTRATIONS ARE NOT TO SCALE

