

ALTAIR™-E & ALTAIRDLX™-E SERIES

DIRECT-VENT FIREPLACES

Appliance Specifications

Framing Dimensions - Inches (millimeters)				
Model	A *	B	C	D
40" DLX	40-7/8 (1039)	41-1/4 (1048)	55-3/4 (1417)	23 (585)
45" DLX	45-7/8 (1166)	41-1/4 (1048)	55-3/4 (1417)	23 (585)
40" non-DLX	40-7/8 (1039)	41-1/4 (1048)	43-3/4 (1111)	23 (585)
45" non-DLX	45-7/8 (1166)	41-1/4 (1048)	43-3/4 (1111)	23 (585)

Model	F	G	H	J	K
40" DLX	40-7/8 (1039)	78-1/4 (1988)	55-1/2 (1410)	40-1/2 (1029)	15-7/8 (404)
45" DLX	45-7/8 (1166)	85-7/8 (2182)	61 (1550)	40-1/2 (1029)	17-1/2 (445)
40" non-DLX	40-7/8 (1039)	78-1/4 (1988)	45-3/8 (1153)	40-1/2 (1029)	15-7/8 (404)
45" non-DLX	45-7/8 (1166)	85-7/8 (2182)	61 (1550)	40-1/2 (1029)	17-1/2 (445)

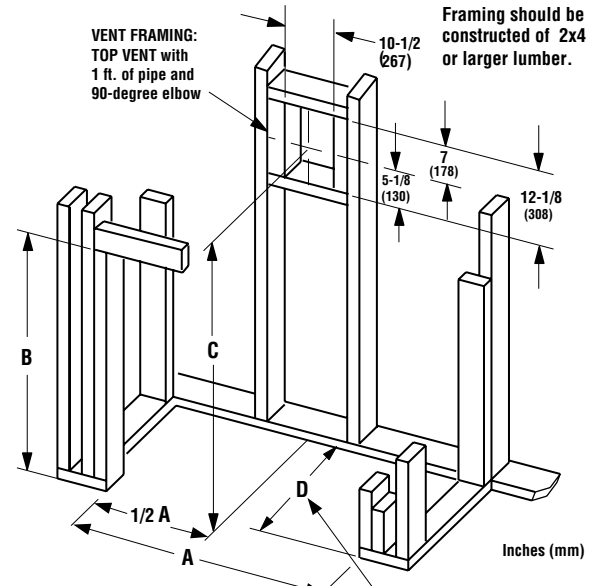

Inches (millimeters)

Dimension "D" is required framing depth when finish material (drywall) thickness is 1/2 (13).

Framing Dimensions

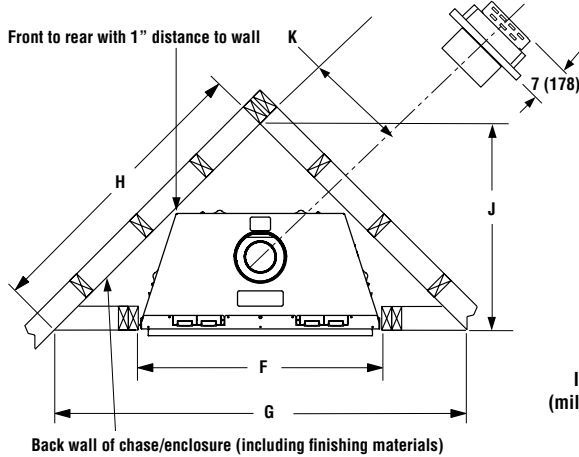

C = Minimum height of top vent installations
* Minimum opening size; additional 1/8" per side is recommended.

NOTE: Framing specifications do NOT apply for flexible venting. When using flexible venting, refer to the instruction manual for framing dimensions.

Fireplace Dimensions

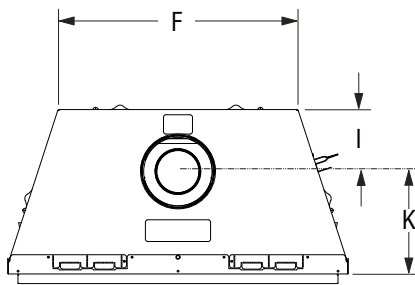

Top View

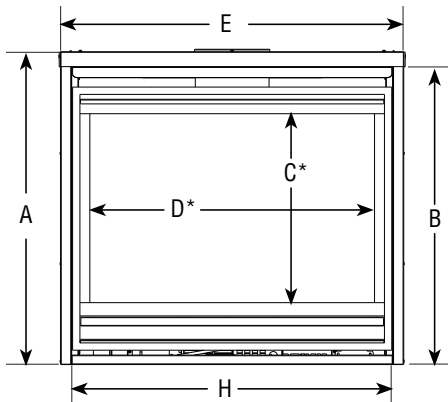

Front View

Model	A	B	C*	D*	E	F
40" Models	37-1/8 (943)	35-1/2 (902)	24-1/2 (623)	34-1/4 (870)	40-1/4 (1022)	30 (762)
45" Models	37-1/8 (943)	35-1/2 (902)	24-1/2 (623)	39-1/4 (997)	45-1/4 (1149)	35 (889)

Model	H	I	J	K
40" Models	37-7/8 (962)	6-7/8 (175)	21 (534)	12-3/8 (315)
45" Models	42-7/8 (1089)	6-7/8 (175)	21 (534)	12-3/8 (315)

* C and D are glass viewing area dimensions

Inches (millimeters)

Diagrams, illustrations and photographs are not to scale. Consult installation instructions. Product designs, materials, dimensions, specifications, colors, and prices are subject to change or discontinuance without notice.

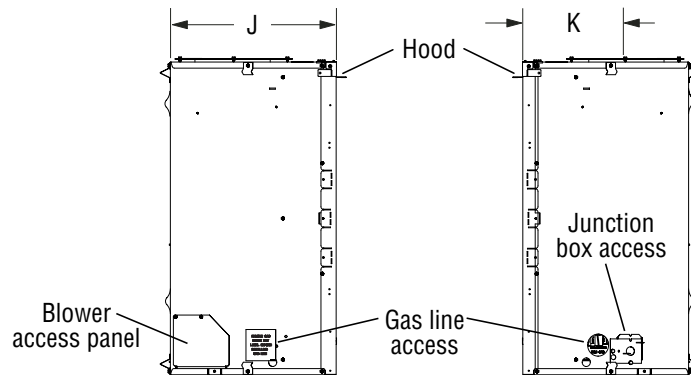

Left Side View

Right Side View

ALTAIR™-E & ALTAIRDLX™-E SERIES

Shelf Height Product Reference Info

Product Reference Information			
Cat. No.	Model	Ship. Wt.	Ship. Volume
F4985	ALTAIR40TEN-E	210 lb.	43 cu. ft.
F4986	ALTAIR40TEP-E		
F4987	ALTAIR45TEN-E	223 lb.	43 cu. ft.
F4988	ALTAIR45TEP-E		

Product Reference Information			
Cat. No.	Model	Ship. Wt.	Ship. Volume
F4989	ALTAIRDLX40TEN-E	210 lb.	43 cu. ft.
F4990	ALTAIRDLX40TEP-E		
F4991	ALTAIRDLX45TEN-E	223 lb.	43 cu. ft.
F4992	ALTAIRDLX45TEP-E		

Listing Info



Tested to ANSI Z21.50 (in Canada, CSA-A-2.22) & CSA 2.17:17 (R2022) in both USA and Canada, as vented gas fireplace heaters.

Shelf Height Minimum Clearances

Model	Top Vent with 90° Elbow ***	
	Secure Vent® (using rigid elbow)	Secure Flex® (using flex elbow)
Altair40 -E	52" (1321 mm) *	54" (1372 mm) *
Altair45 -E	52" (1321 mm) *	54" (1372 mm) *
AltairDLX40 -E	68" (1727 mm) *	70" (1778 mm) *
AltairDLX45 -E	68" (1727 mm) *	70" (1778 mm) *

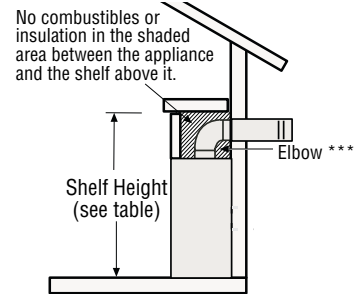

* Includes 3" clearance to combustibles (required above vent components)

*** 40" DLX models and 45" DLX models must use, at a minimum, a 1 foot vertical section before connecting an elbow.

Clearances

Minimum Clearances ❶ Inches (millimeters)	
Back	1-1/2" (38mm) to wrapper 0" (0 mm) to Spacers
Sides	1/2" (13 mm) to wrapper 0" (0 mm) to Spacers ❷
Top Standoffs	0" (0 mm) to top standoffs
Floor	0" (0 mm)
From Bottom of Unit To Ceiling	64" (1626 mm)
Vent	3 (77) Top ❶ 1 (26) Sides & Bottom
SERVICE CLEARANCES Feet (meters)	
Front	3 feet (0.9 meters)

❶ NOTE: 3" (77 mm) above any horizontal/inclined vent component.

❷ NOTE: See Installation Instructions Manual (Step 1) for clearance requirements to the nailing flange located at each side of the unit and any screw heads adjacent to it.

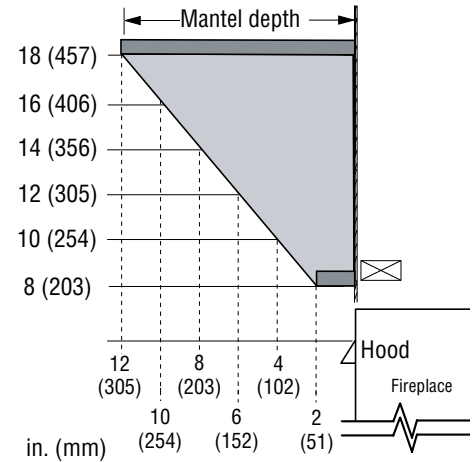
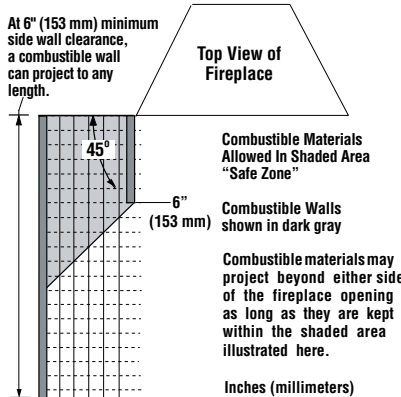

Venting Requirements

